



TEST REPORT FROM RFI GLOBAL SERVICES LTD

Test of: Powerline Ethernet Adaptors

To: EN 55022: 1998

Test Report Serial No:
RFI/EMC2/RP73935JD01A

Supersedes Test Report Serial No:
RFI/EMC1/RP73935JD01A

This Test Report Is Issued Under The Authority Of Steve Flooks, Service Leader:	
	
Checked By:	Claire Ashman
Signature:	
Date of Issue:	17 September 2008

This report is issued in Adobe Acrobat portable document format (PDF). It is only a valid copy of the report if it is being viewed in PDF format with the following security options not allowed: Changing the document, Selecting text and graphics, Adding or changing notes and form fields.

This report may not be reproduced other than in full, except with the prior written approval of RFI Global Services Ltd. The results in this report apply only to the sample(s) tested.

This page has been left intentionally blank.

Table of Contents

1. Customer Information	4
2. Summary of Testing	5
3. Equipment Under Test (EUT)	6
4. Operation and Monitoring of the EUT during Testing	8
5. Measurements, Examinations and Derived Results	9
6. Measurement Uncertainty	41
Appendix 1. Test Equipment Used	42
Appendix 2. Test Configuration Drawings	43
Appendix 3. Graphical Test Results.....	45

1. Customer Information







Company Name:	ERA Technology Ltd
Address:	Cleeve Road Leatherhead Surrey KT22 7SA

2. Summary of Testing

2.1. General Information

Specification Reference:	EN 55022: 1998
Specification Title:	Information technology equipment - Radio disturbance characteristics - Limits and methods of measurement
Location of Testing:	RFI Global Services Ltd, Ewhurst Park, Basingstoke, Hampshire, RG26 5RQ.
Test Dates:	29 August 2008

2.2. Summary of Test Results

Clause	Measurement	Applicability	Result
9	Conducted disturbance at mains terminals and telecommunication ports	Y	
10	Radiated disturbance	Y	
Key to Results			
 = Complied  = Complied, within uncertainty  = Did not comply, within uncertainty  = Did not comply			

2.3. Deviations from the Test Specification

At the request of the customer, radiated emissions measurements were performed on one face of the EUT only.

3. Equipment Under Test (EUT)

3.1. Identification of Equipment Under Test (EUT)

Description:	Sample 5, Unit 1
Brand Name:	Comtrend
Model Name or Number:	Powergrid 902
Serial Number:	08051003886A

Description:	Sample 5 Unit 2
Brand Name:	Comtrend
Model Name or Number:	Powergrid 902
Serial Number:	08051003886B

Description:	Sample 3, Unit 1
Brand Name:	Comtrend
Model Name or Number:	Powergrid DH-10PF
Serial Number:	07071000232B

Description:	Sample 3, Unit 2
Brand Name:	Comtrend
Model Name or Number:	Powergrid DH-10PF
Serial Number:	07051000157A

Description:	Sample 4, Unit 1
Brand Name:	Comtrend
Model Name or Number:	Powergrid 902
Serial Number:	08051003891A

Description:	Sample 4, Unit 2
Brand Name:	Comtrend
Model Name or Number:	Powergrid 902
Serial Number:	08051003891B

3.2. Description of EUT

The equipment under test were Power-line Ethernet Adaptors.

3.3. Modifications Incorporated in the EUT

No modifications were applied to the EUT during testing.

3.4. Additional Information Related to Testing

Equipment Category:	Information technology equipment
Equipment Classification:	Class B ITE
Test Configuration:	Table top equipment
Type of Unit:	Power-line Ethernet Adaptors
Intended Operating Environment:	Residential/Commercial
Power Supply Requirement:	Nominal 230/240 V, 50 Hz AC Mains Supply
Cycle Time:	Less than 2.5 seconds

3.5. Port Identification

Port	Description	Type	Applicable
1	Enclosure	-	Y
2	Ethernet	CAT5, >3m	Y
3	AC Input	Earth, Neutral, Live Pin, <3m	Y

3.6. Support Equipment

The following support equipment was used to exercise the EUT during testing:

Description:	Laptop
Brand Name:	Ergo XL
Model Name or Number:	M2400 Series
Serial Number:	25NP812260
Cable Length and Type:	-
Connected to Port:	-

Description:	Laptop
Brand Name:	Mercury
Model Name or Number:	700A
Serial Number:	3892D402
Cable Length and Type:	Mains 3 Core, <3m
Connected to Port:	AC Input

4. Operation and Monitoring of the EUT during Testing

4.1. Operating Modes

The EUT was tested in the following operating mode(s):

- Two adaptors were powered and connected in series, each adaptor was then connected to a laptop between which data was transferred.

This configuration was chosen because it was defined by the customer as being typical of normal use and likely to be a worst case with regard to EMC.

The following additional following reduced configurations were also tested:

- Two adaptors powered and connected in series, each adaptor was then connected to a laptop but with no data was transferred.
- Two adaptors powered and connected in series.
- One adaptor powered standalone.

5. Measurements, Examinations and Derived Results

5.1. General Comments

Measurement uncertainties are evaluated in accordance with current best practice. Our reported expanded uncertainties are based on standard uncertainties, which are multiplied by an appropriate coverage factor to provide a statistical confidence level of approximately 95%. Please refer to *Section 6. Measurement Uncertainty* for details.

5.2. Conducted Disturbance At Mains Terminals And Telecommunication Ports

5.2.1. Quasi Peak Detector Measurements

Plots of the initial scans can be found in *Appendix 3. Graphical Test Results.*

Test Summary:

Port:	Signal/Telecommunications
Basic Standard:	EN 55022: 1998
Operating Mode:	Current Clamp Unit CH3 Ethernet No Data

Environmental Conditions:

Temperature Variation (°C):	28 to 28
Relative Humidity Variation (%):	60 to 60
Atmospheric Pressure Variation (mb):	1011 to 1011

Results:

Frequency (MHz)	Line	Quasi Peak Level (dBμA)	Limit (dBμA)	Margin (dB)	Note(s)	Result
12.341	Ethernet	44.7	30.0	-14.7	-	Did Not Comply
12.503	Ethernet	45.0	30.0	-15.0	-	Did Not Comply
13.124	Ethernet	43.6	30.0	-13.6	-	Did Not Comply
17.345	Ethernet	42.2	30.0	-12.2	-	Did Not Comply

5.2.2. Average Detector Measurements

Following the initial scans and quasi peak measurements, further measurements were made at the relevant frequencies using an average detector. The measured levels were as follows:

Test Summary:

Port:	Signal/Telecommunications
Basic Standard:	EN 55022: 1998
Operating Mode:	Current Clamp Unit CH3 Ethernet No Data

Environmental Conditions:

Temperature Variation (°C):	28 to 28
Relative Humidity Variation (%):	60 to 60
Atmospheric Pressure Variation (mb):	1011 to 1011

Results:

Frequency (MHz)	Line	Average Level (dBμA)	Limit (dBμA)	Margin (dB)	Note(s)	Result
12.341	Ethernet	31.8	20.0	-11.8	-	Did Not Comply
12.503	Ethernet	32.2	20.0	-12.2	-	Did Not Comply
13.124	Ethernet	30.8	20.0	-10.8	-	Did Not Comply

5.2.3. Quasi Peak Detector Measurements

Plots of the initial scans can be found in *Appendix 3. Graphical Test Results.*

Test Summary:

Port:	Signal/Telecommunications
Basic Standard:	EN 55022: 1998
Operating Mode:	Current Clamp Unit CH4 Ethernet Data

Environmental Conditions:

Temperature Variation (°C):	28 to 28
Relative Humidity Variation (%):	60 to 60
Atmospheric Pressure Variation (mb):	1011 to 1011

Results:

Frequency (MHz)	Line	Quasi Peak Level (dB μ A)	Limit (dB μ A)	Margin (dB)	Note(s)	Result
9.690	Ethernet	35.1	30.0	-5.1	-	Did Not Comply
10.563	Ethernet	34.2	30.0	-4.2	-	Did Not Comply
10.788	Ethernet	32.9	30.0	-2.9	-	Did Not Comply
11.409	Ethernet	38.7	30.0	-8.7	-	Did Not Comply
12.656	Ethernet	37.2	30.0	-7.2	-	Did Not Comply

5.2.4. Average Detector Measurements

Following the initial scans and quasi peak measurements, further measurements were made at the relevant frequencies using an average detector. The measured levels were as follows:

Test Summary:

Port:	Signal/Telecommunications
Basic Standard:	EN 55022: 1998
Operating Mode:	Current Clamp Unit CH4 Ethernet Data

Environmental Conditions:

Temperature Variation (°C):	28 to 28
Relative Humidity Variation (%):	60 to 60
Atmospheric Pressure Variation (mb):	1011 to 1011

Results:

Frequency (MHz)	Line	Average Level (dBμA)	Limit (dBμA)	Margin (dB)	Note(s)	Result
12.030	Ethernet	26.7	20.0	-6.7	-	Did Not Comply
12.818	Ethernet	26.3	20.0	-6.3	-	Did Not Comply
13.344	Ethernet	24.1	20.0	-4.1	-	Did Not Comply
13.556	Ethernet	24.5	20.0	-4.5	-	Did Not Comply

5.2.5. Quasi Peak Detector Measurements

Plots of the initial scans can be found in *Appendix 3. Graphical Test Results.*

Test Summary:

Port:	Signal/Telecommunications
Basic Standard:	EN 55022: 1998
Operating Mode:	Current Clamp Unit CH4 Ethernet No Data

Environmental Conditions:

Temperature Variation (°C):	28 to 28
Relative Humidity Variation (%):	60 to 60
Atmospheric Pressure Variation (mb):	1011 to 1011

Results:

Frequency (MHz)	Line	Quasi Peak Level (dB μ A)	Limit (dB μ A)	Margin (dB)	Note(s)	Result
2.769	Ethernet	21.6	30.0	8.4	-	Complied
4.412	Ethernet	20.2	30.0	9.8	-	Complied
10.626	Ethernet	33.1	30.0	-3.1	-	Did Not Comply
11.409	Ethernet	38.6	30.0	-8.6	-	Did Not Comply
12.030	Ethernet	39.6	30.0	-9.6	-	Did Not Comply

5.2.6. Average Detector Measurements

Following the initial scans and quasi peak measurements, further measurements were made at the relevant frequencies using an average detector. The measured levels were as follows:

Test Summary:

Port:	Signal/Telecommunications
Basic Standard:	EN 55022: 1998
Operating Mode:	Current Clamp Unit CH4 Ethernet No Data

Environmental Conditions:

Temperature Variation (°C):	28 to 28
Relative Humidity Variation (%):	60 to 60
Atmospheric Pressure Variation (mb):	1011 to 1011

Results:

Frequency (MHz)	Line	Average Level (dB μ A)	Limit (dB μ A)	Margin (dB)	Note(s)	Result
2.652	Ethernet	11.7	20.0	8.3	-	Complied
4.412	Ethernet	8.6	20.0	11.4	-	Complied
12.030	Ethernet	27.0	20.0	-7.0	-	Did Not Comply
12.507	Ethernet	24.7	20.0	-4.7	-	Did Not Comply
13.124	Ethernet	26.4	20.0	-6.4	-	Did Not Comply
13.281	Ethernet	25.4	20.0	-5.4	-	Did Not Comply

5.2.7. Quasi Peak Detector Measurements

Plots of the initial scans can be found in *Appendix 3. Graphical Test Results.*

Test Summary:

Port:	Signal/Telecommunications
Basic Standard:	EN 55022: 1998
Operating Mode:	Unit CH3 Ethernet Data

Environmental Conditions:

Temperature Variation (°C):	28 to 28
Relative Humidity Variation (%):	60 to 60
Atmospheric Pressure Variation (mb):	1011 to 1011

Results:

Frequency (MHz)	Line	Quasi Peak Level (dB μ A)	Limit (dB μ A)	Margin (dB)	Note(s)	Result
11.567	Ethernet	43.2	30.0	-13.2	-	Did Not Comply
12.026	Ethernet	43.3	30.0	-13.3	-	Did Not Comply
15.626	Ethernet	39.9	30.0	-9.9	-	Did Not Comply
16.562	Ethernet	41.8	30.0	-11.8	-	Did Not Comply
17.349	Ethernet	40.1	30.0	-10.1	-	Did Not Comply

5.2.8. Average Detector Measurements

Following the initial scans and quasi peak measurements, further measurements were made at the relevant frequencies using an average detector. The measured levels were as follows:

Test Summary:

Port:	Signal/Telecommunications
Basic Standard:	EN 55022: 1998
Operating Mode:	Unit CH3 Ethernet Data

Environmental Conditions:

Temperature Variation (°C):	28 to 28
Relative Humidity Variation (%):	60 to 60
Atmospheric Pressure Variation (mb):	1011 to 1011

Results:

Frequency (MHz)	Line	Average Level (dB μ A)	Limit (dB μ A)	Margin (dB)	Note(s)	Result
10.937	Ethernet	31.6	20.0	-11.6	-	Did Not Comply
11.094	Ethernet	31.9	20.0	-11.9	-	Did Not Comply
12.035	Ethernet	31.7	20.0	-11.7	-	Did Not Comply
14.843	Ethernet	28.4	20.0	-8.4	-	Did Not Comply
16.562	Ethernet	30.4	20.0	-10.4	-	Did Not Comply

5.2.9. Quasi Peak Detector Measurements

Plots of the initial scans can be found in *Appendix 3. Graphical Test Results.*

Test Summary:

Port:	AC Mains
Basic Standard:	EN 55022: 1998
Operating Mode:	Unit CH3 Ethernet Unplugged Unit 1

Environmental Conditions:

Temperature Variation (°C):	28 to 28
Relative Humidity Variation (%):	60 to 60
Atmospheric Pressure Variation (mb):	1011 to 1011

Results:

Frequency (MHz)	Line	Quasi Peak Level (dB μ V)	Limit (dB μ V)	Margin (dB)	Note(s)	Result
2.657	Neutral	95.4	56.0	-39.4	-	Did Not Comply
3.125	Neutral	93.0	56.0	-37.0	-	Did Not Comply
4.376	Neutral	92.1	56.0	-36.1	-	Did Not Comply
4.686	Neutral	92.1	56.0	-36.1	-	Did Not Comply

5.2.10. Average Detector Measurements

Following the initial scans and quasi peak measurements, further measurements were made at the relevant frequencies using an average detector. The measured levels were as follows:

Test Summary:

Port:	AC Mains
Basic Standard:	EN 55022: 1998
Operating Mode:	Unit CH3 Ethernet Unplugged Unit 1

Environmental Conditions:

Temperature Variation (°C):	28 to 28
Relative Humidity Variation (%):	60 to 60
Atmospheric Pressure Variation (mb):	1011 to 1011

Results:

Frequency (MHz)	Line	Average Level (dBμV)	Limit (dBμV)	Margin (dB)	Note(s)	Result
2.657	Live	81.5	46.0	-35.5	-	Did Not Comply
4.371	Neutral	80.2	46.0	-34.2	-	Did Not Comply
4.569	Neutral	79.8	46.0	-33.8	-	Did Not Comply
4.646	Live	80.1	46.0	-34.1	-	Did Not Comply

5.2.11. Quasi Peak Detector Measurements

Plots of the initial scans can be found in *Appendix 3. Graphical Test Results.*

Test Summary:

Port:	AC Mains
Basic Standard:	EN 55022: 1998
Operating Mode:	Unit CH3 Ethernet Unplugged Unit 2

Environmental Conditions:

Temperature Variation (°C):	28 to 28
Relative Humidity Variation (%):	60 to 60
Atmospheric Pressure Variation (mb):	1011 to 1011

Results:

Frequency (MHz)	Line	Quasi Peak Level (dB μ V)	Limit (dB μ V)	Margin (dB)	Note(s)	Result
2.657	Neutral	94.5	56.0	-38.5	-	Did Not Comply
2.850	Neutral	93.6	56.0	-37.6	-	Did Not Comply
3.125	Neutral	91.6	56.0	-35.6	-	Did Not Comply
4.686	Neutral	90.9	56.0	-34.9	-	Did Not Comply

5.2.12. Average Detector Measurements

Following the initial scans and quasi peak measurements, further measurements were made at the relevant frequencies using an average detector. The measured levels were as follows:

Test Summary:

Port:	AC Mains
Basic Standard:	EN 55022: 1998
Operating Mode:	Unit CH3 Ethernet Unplugged Unit 2

Environmental Conditions:

Temperature Variation (°C):	28 to 28
Relative Humidity Variation (%):	60 to 60
Atmospheric Pressure Variation (mb):	1011 to 1011

Results:

Frequency (MHz)	Line	Average Level (dBμV)	Limit (dBμV)	Margin (dB)	Note(s)	Result
2.657	Live	81.5	46.0	-35.5	-	Did Not Comply
2.850	Live	81.7	46.0	-35.7	-	Did Not Comply
4.371	Neutral	80.5	46.0	-34.5	-	Did Not Comply
4.848	Live	79.5	46.0	-33.5	-	Did Not Comply

5.2.13. Quasi Peak Detector Measurements

Plots of the initial scans can be found in *Appendix 3. Graphical Test Results.*

Test Summary:

Port:	AC Mains
Basic Standard:	EN 55022: 1998
Operating Mode:	Unit CH3 Full Setup

Environmental Conditions:

Temperature Variation (°C):	28 to 28
Relative Humidity Variation (%):	60 to 60
Atmospheric Pressure Variation (mb):	1011 to 1011

Results:

Frequency (MHz)	Line	Quasi Peak Level (dBμV)	Limit (dBμV)	Margin (dB)	Note(s)	Result
2.481	Live	92.6	56.0	-36.6	-	Did Not Comply
4.574	Live	89.2	56.0	-33.2	-	Did Not Comply
7.931	Neutral	90.0	60.0	-30.0	-	Did Not Comply
11.369	Live	87.6	60.0	-27.6	-	Did Not Comply

5.2.14. Average Detector Measurements

Following the initial scans and quasi peak measurements, further measurements were made at the relevant frequencies using an average detector. The measured levels were as follows:

Test Summary:

Port:	AC Mains
Basic Standard:	EN 55022: 1998
Operating Mode:	Unit CH3 Full Setup

Environmental Conditions:

Temperature Variation (°C):	28 to 28
Relative Humidity Variation (%):	60 to 60
Atmospheric Pressure Variation (mb):	1011 to 1011

Results:

Frequency (MHz)	Line	Average Level (dBμV)	Limit (dBμV)	Margin (dB)	Note(s)	Result
2.481	Live	81.6	46.0	-35.6	-	Did Not Comply
3.129	Live	82.3	46.0	-36.3	-	Did Not Comply
5.622	Neutral	82.3	50.0	-32.3	-	Did Not Comply
14.843	Live	80.3	50.0	-30.3	-	Did Not Comply

5.2.15. Quasi Peak Detector Measurements

Plots of the initial scans can be found in *Appendix 3. Graphical Test Results.*

Test Summary:

Port:	AC Mains
Basic Standard:	EN 55022: 1998
Operating Mode:	Unit CH3 Full Setup No Data

Environmental Conditions:

Temperature Variation (°C):	28 to 28
Relative Humidity Variation (%):	60 to 60
Atmospheric Pressure Variation (mb):	1011 to 1011

Results:

Frequency (MHz)	Line	Quasi Peak Level (dBμV)	Limit (dBμV)	Margin (dB)	Note(s)	Result
2.810	Live	93.9	56.0	-37.9	-	Did Not Comply
2.967	Live	91.1	56.0	-35.1	-	Did Not Comply
3.125	Neutral	91.6	56.0	-35.6	-	Did Not Comply
4.686	Neutral	90.9	56.0	-34.9	-	Did Not Comply

5.2.16. Average Detector Measurements

Following the initial scans and quasi peak measurements, further measurements were made at the relevant frequencies using an average detector. The measured levels were as follows:

Test Summary:

Port:	AC Mains
Basic Standard:	EN 55022: 1998
Operating Mode:	Unit CH3 Full Setup No Data

Environmental Conditions:

Temperature Variation (°C):	28 to 28
Relative Humidity Variation (%):	60 to 60
Atmospheric Pressure Variation (mb):	1011 to 1011

Results:

Frequency (MHz)	Line	Average Level (dBμV)	Limit (dBμV)	Margin (dB)	Note(s)	Result
2.657	Neutral	81.5	46.0	-35.5	-	Did Not Comply
3.044	Neutral	80.7	46.0	-34.7	-	Did Not Comply
4.371	Live	80.5	46.0	-34.5	-	Did Not Comply
4.988	Live	76.5	46.0	-30.5	-	Did Not Comply

5.2.17. Quasi Peak Detector Measurements

Plots of the initial scans can be found in *Appendix 3. Graphical Test Results.*

Test Summary:

Port:	AC Mains
Basic Standard:	EN 55022: 1998
Operating Mode:	Unit CH4 Ethernet Unplugged Unit 1

Environmental Conditions:

Temperature Variation (°C):	28 to 28
Relative Humidity Variation (%):	60 to 60
Atmospheric Pressure Variation (mb):	1011 to 1011

Results:

Frequency (MHz)	Line	Quasi Peak Level (dB μ V)	Limit (dB μ V)	Margin (dB)	Note(s)	Result
2.657	Neutral	93.2	56.0	-37.2	-	Did Not Comply
5.078	Neutral	91.3	60.0	-31.3	-	Did Not Comply
5.078	Neutral	91.6	60.0	-31.6	-	Did Not Comply
8.592	Live	90.6	60.0	-30.6	-	Did Not Comply
12.183	Live	91.8	60.0	-31.8	-	Did Not Comply
16.098	Live	91.5	60.0	-31.5	-	Did Not Comply
20.162	Neutral	90.1	60.0	-30.1	-	Did Not Comply
22.655	Neutral	89.1	60.0	-29.1	-	Did Not Comply
25.782	Neutral	89.1	60.0	-29.1	-	Did Not Comply

5.2.18. Average Detector Measurements

Following the initial scans and quasi peak measurements, further measurements were made at the relevant frequencies using an average detector. The measured levels were as follows:

Test Summary:

Port:	AC Mains
Basic Standard:	EN 55022: 1998
Operating Mode:	Unit CH4 Ethernet Unplugged Unit 1

Environmental Conditions:

Temperature Variation (°C):	28 to 28
Relative Humidity Variation (%):	60 to 60
Atmospheric Pressure Variation (mb):	1011 to 1011

Results:

Frequency (MHz)	Line	Average Level (dB μ V)	Limit (dB μ V)	Margin (dB)	Note(s)	Result
2.499	Live	81.4	46.0	-35.4	-	Did Not Comply
3.129	Neutral	80.0	46.0	-34.0	-	Did Not Comply
5.586	Live	78.4	50.0	-28.4	-	Did Not Comply
8.435	Live	76.6	50.0	-26.6	-	Did Not Comply
12.030	Live	78.8	50.0	-28.8	-	Did Not Comply
15.932	Live	77.8	50.0	-27.8	-	Did Not Comply
19.527	Live	78.4	50.0	-28.4	-	Did Not Comply
23.087	Live	78.1	50.0	-28.1	-	Did Not Comply
25.215	Neutral	64.6	50.0	-14.6	-	Did Not Comply

5.2.19. Quasi Peak Detector Measurements

Plots of the initial scans can be found in *Appendix 3. Graphical Test Results.*

Test Summary:

Port:	AC Mains
Basic Standard:	EN 55022: 1998
Operating Mode:	Unit CH4 Ethernet Unplugged Unit 2

Environmental Conditions:

Temperature Variation (°C):	28 to 28
Relative Humidity Variation (%):	60 to 60
Atmospheric Pressure Variation (mb):	1011 to 1011

Results:

Frequency (MHz)	Line	Quasi Peak Level (dB μ V)	Limit (dB μ V)	Margin (dB)	Note(s)	Result
2.972	Neutral	92.2	56.0	-36.2	-	Did Not Comply
3.129	Neutral	93.3	56.0	-37.3	-	Did Not Comply
4.848	Neutral	90.8	56.0	-34.8	-	Did Not Comply
8.588	Live	87.1	60.0	-27.1	-	Did Not Comply
11.409	Live	89.1	60.0	-29.1	-	Did Not Comply
16.098	Live	89.9	60.0	-29.9	-	Did Not Comply
19.379	Neutral	88.0	60.0	-28.0	-	Did Not Comply
23.438	Neutral	87.4	60.0	-27.4	-	Did Not Comply
25.625	Live	88.2	60.0	-28.2	-	Did Not Comply

5.2.20. Average Detector Measurements

Following the initial scans and quasi peak measurements, further measurements were made at the relevant frequencies using an average detector. The measured levels were as follows:

Test Summary:

Port:	AC Mains
Basic Standard:	EN 55022: 1998
Operating Mode:	Unit CH4 Ethernet Unplugged Unit 2

Environmental Conditions:

Temperature Variation (°C):	28 to 28
Relative Humidity Variation (%):	60 to 60
Atmospheric Pressure Variation (mb):	1011 to 1011

Results:

Frequency (MHz)	Line	Average Level (dB μ V)	Limit (dB μ V)	Margin (dB)	Note(s)	Result
2.972	Live	80.6	46.0	-34.6	-	Did Not Comply
3.129	Neutral	79.8	46.0	-33.8	-	Did Not Comply
4.371	Live	78.3	46.0	-32.3	-	Did Not Comply
8.745	Live	76.8	50.0	-26.8	-	Did Not Comply
12.035	Neutral	77.5	50.0	-27.5	-	Did Not Comply
16.098	Live	76.5	50.0	-26.5	-	Did Not Comply
19.221	Neutral	75.9	50.0	-25.9	-	Did Not Comply
23.438	Live	75.2	50.0	-25.2	-	Did Not Comply

5.2.21. Quasi Peak Detector Measurements

Plots of the initial scans can be found in *Appendix 3. Graphical Test Results.*

Test Summary:

Port:	AC Mains
Basic Standard:	EN 55022: 1998
Operating Mode:	Unit CH4 Full Setup

Environmental Conditions:

Temperature Variation (°C):	28 to 28
Relative Humidity Variation (%):	60 to 60
Atmospheric Pressure Variation (mb):	1011 to 1011

Results:

Frequency (MHz)	Line	Quasi Peak Level (dB μ V)	Limit (dB μ V)	Margin (dB)	Note(s)	Result
2.364	Neutral	92.4	56.0	-36.4	-	Did Not Comply
3.129	Neutral	93.2	56.0	-37.2	-	Did Not Comply
4.371	Neutral	91.8	56.0	-35.8	-	Did Not Comply
5.942	Neutral	91.0	60.0	-31.0	-	Did Not Comply
6.162	Neutral	85.3	60.0	-25.3	-	Did Not Comply
12.030	Live	90.8	60.0	-30.8	-	Did Not Comply
16.098	Live	90.7	60.0	-30.7	-	Did Not Comply

5.2.22. Average Detector Measurements

Following the initial scans and quasi peak measurements, further measurements were made at the relevant frequencies using an average detector. The measured levels were as follows:

Test Summary:

Port:	AC Mains
Basic Standard:	EN 55022: 1998
Operating Mode:	Unit CH4 Full Setup

Environmental Conditions:

Temperature Variation (°C):	28 to 28
Relative Humidity Variation (%):	60 to 60
Atmospheric Pressure Variation (mb):	1011 to 1011

Results:

Frequency (MHz)	Line	Average Level (dBμV)	Limit (dBμV)	Margin (dB)	Note(s)	Result
2.342	Live	82.8	46.0	-36.8	-	Did Not Comply
3.129	Neutral	81.2	46.0	-35.2	-	Did Not Comply
4.376	Live	78.4	46.0	-32.4	-	Did Not Comply
4.848	Neutral	79.3	46.0	-33.3	-	Did Not Comply
16.719	Live	77.9	50.0	-27.9	-	Did Not Comply

5.2.23. Quasi Peak Detector Measurements

Plots of the initial scans can be found in *Appendix 3. Graphical Test Results.*

Test Summary:

Port:	AC Mains
Basic Standard:	EN 55022: 1998
Operating Mode:	Unit CH4 Full Setup No Data

Environmental Conditions:

Temperature Variation (°C):	28 to 28
Relative Humidity Variation (%):	60 to 60
Atmospheric Pressure Variation (mb):	1011 to 1011

Results:

Frequency (MHz)	Line	Quasi Peak Level (dB μ V)	Limit (dB μ V)	Margin (dB)	Note(s)	Result
2.351	Neutral	91.5	56.0	-35.5	-	Did Not Comply
3.129	Neutral	93.3	56.0	-37.3	-	Did Not Comply
4.371	Neutral	91.9	56.0	-35.9	-	Did Not Comply
5.316	Neutral	89.7	60.0	-29.7	-	Did Not Comply
8.592	Live	89.5	60.0	-29.5	-	Did Not Comply

5.2.24. Average Detector Measurements

Following the initial scans and quasi peak measurements, further measurements were made at the relevant frequencies using an average detector. The measured levels were as follows:

Test Summary:

Port:	AC Mains
Basic Standard:	EN 55022: 1998
Operating Mode:	Unit CH4 Full Setup No Data

Environmental Conditions:

Temperature Variation (°C):	28 to 28
Relative Humidity Variation (%):	60 to 60
Atmospheric Pressure Variation (mb):	1011 to 1011

Results:

Frequency (MHz)	Line	Average Level (dB μ V)	Limit (dB μ V)	Margin (dB)	Note(s)	Result
2.495	Live	81.4	46.0	-35.4	-	Did Not Comply
2.850	Neutral	80.8	46.0	-34.8	-	Did Not Comply
2.972	Neutral	80.4	46.0	-34.4	-	Did Not Comply
3.129	Neutral	79.6	46.0	-33.6	-	Did Not Comply
4.376	Neutral	78.4	46.0	-32.4	-	Did Not Comply
5.316	Neutral	76.8	50.0	-26.8	-	Did Not Comply
8.592	Live	77.0	50.0	-27.0	-	Did Not Comply

5.2.25. Quasi Peak Detector Measurements

Plots of the initial scans can be found in *Appendix 3. Graphical Test Results.*

Test Summary:

Port:	AC Mains
Basic Standard:	EN 55022: 1998
Operating Mode:	Unit CH5 Full Setup

Environmental Conditions:

Temperature Variation (°C):	28 to 28
Relative Humidity Variation (%):	60 to 60
Atmospheric Pressure Variation (mb):	1011 to 1011

Results:

Frequency (MHz)	Line	Quasi Peak Level (dB μ V)	Limit (dB μ V)	Margin (dB)	Note(s)	Result
2.594	Live	90.6	56.0	-34.6	-	Did Not Comply
4.416	Neutral	90.9	56.0	-34.9	-	Did Not Comply
6.090	Neutral	91.0	60.0	-31.0	-	Did Not Comply
6.252	Neutral	89.9	60.0	-29.9	-	Did Not Comply
8.282	Live	90.8	60.0	-30.8	-	Did Not Comply
8.435	Live	90.7	60.0	-30.7	-	Did Not Comply
9.218	Live	88.2	60.0	-28.2	-	Did Not Comply
11.252	Live	88.8	60.0	-28.8	-	Did Not Comply
13.128	Live	90.9	60.0	-30.9	-	Did Not Comply
15.315	Live	89.7	60.0	-29.7	-	Did Not Comply
19.649	Neutral	80.7	60.0	-20.7	-	Did Not Comply
22.502	Live	86.6	60.0	-26.6	-	Did Not Comply
25.395	Live	83.2	60.0	-23.2	-	Did Not Comply

5.2.26. Average Detector Measurements

Following the initial scans and quasi peak measurements, further measurements were made at the relevant frequencies using an average detector. The measured levels were as follows:

Test Summary:

Port:	AC Mains
Basic Standard:	EN 55022: 1998
Operating Mode:	Unit CH5 Full Setup

Environmental Conditions:

Temperature Variation (°C):	28 to 28
Relative Humidity Variation (%):	60 to 60
Atmospheric Pressure Variation (mb):	1011 to 1011

Results:

Frequency (MHz)	Line	Average Level (dB μ V)	Limit (dB μ V)	Margin (dB)	Note(s)	Result
2.346	Neutral	82.7	46.0	-36.7	-	Did Not Comply
2.657	Neutral	82.3	46.0	-36.3	-	Did Not Comply
3.129	Neutral	80.2	46.0	-34.2	-	Did Not Comply
4.335	Live	78.5	46.0	-32.5	-	Did Not Comply
4.416	Live	79.0	46.0	-33.0	-	Did Not Comply
4.848	Neutral	78.3	46.0	-32.3	-	Did Not Comply
6.095	Neutral	77.2	50.0	-27.2	-	Did Not Comply
8.750	Live	76.6	50.0	-26.6	-	Did Not Comply
12.188	Live	79.1	50.0	-29.1	-	Did Not Comply
15.158	Live	78.7	50.0	-28.7	-	Did Not Comply

5.3. Radiated Disturbance

5.3.1. Electric Field Strength Measurements

Plots of the initial scans can be found in *Appendix 3. Graphical Test Results*.

Test Summary:

Port:	Enclosure
Basic Standard:	EN 55022: 1998
Measurement Distance:	5 m
Frequency Range:	30 MHz to 1 GHz
Operating Mode:	Unit 1, CH3, Laptop 1

Environmental Conditions:

Temperature Variation (°C):	28 to 28
Relative Humidity Variation (%):	60 to 60
Atmospheric Pressure Variation (mb):	1011 to 1011

Results:

Frequency (MHz)	Antenna Polarity	Quasi Peak Level (dBμV/m)	Limit (dBμV/m)	Margin (dB)	Note(s)	Result
30.959519	Vertical	34.6	36.02	1.42	1	Complied
299.818437	Vertical	13.0	43.02	30.02	-	Complied
455.996393	Horizontal	18.0	43.02	25.02	-	Complied
911.590781	Vertical	24.2	43.02	18.82	-	Complied
983.110621	Vertical	25.9	43.02	17.12	-	Complied

Note(s):

1. The measured result is within the test standard limit by a margin less than the measurement uncertainty; it is therefore not possible to state compliance based on the 95% level of confidence. However, the result indicates that compliance is more probable than non-compliance.

5.3.2. Electric Field Strength Measurements

Plots of the initial scans can be found in *Appendix 3. Graphical Test Results.*

Test Summary:

Port:	Enclosure
Basic Standard:	EN 55022: 1998
Measurement Distance:	5 m
Frequency Range:	30 MHz to 1 GHz
Operating Mode:	Unit 2, CH3 No Laptops

Environmental Conditions:

Temperature Variation (°C):	28 to 28
Relative Humidity Variation (%):	60 to 60
Atmospheric Pressure Variation (mb):	1011 to 1011

Results:

Frequency (MHz)	Antenna Polarity	Quasi Peak Level (dB μ V/m)	Limit (dB μ V/m)	Margin (dB)	Note(s)	Result
31.659319	Vertical	35.9	36.02	0.12	1	Complied
51.076153	Vertical	24.3	36.02	11.72	-	Complied
159.962725	Horizontal	33.1	36.02	2.92	1	Complied
319.974750	Horizontal	42.5	43.02	0.52	1	Complied
479.997194	Vertical	50.4	43.02	-7.38	-	Did Not Comply
639.973147	Vertical	41.9	43.02	1.12	1	Complied
719.975551	Horizontal	47.3	43.02	-4.28	2	Did Not Comply
799.966734	Horizontal	42.3	43.02	0.72	1	Complied
879.969139	Horizontal	46.3	43.02	-3.28	2	Did Not Comply
959.949899	Vertical	48.2	43.02	-5.18	-	Did Not Comply

Note(s):

1. The measured result is within the test standard limit by a margin less than the measurement uncertainty; it is therefore not possible to state compliance based on the 95% level of confidence. However, the result indicates that compliance is more probable than non-compliance.
2. The measured result lies outside the test standard limit by a margin less than the measurement uncertainty; it is therefore not possible to state compliance based on the 95% level of confidence. However, the result indicates that non-compliance is more probable than compliance.

5.3.3. Electric Field Strength Measurements

Plots of the initial scans can be found in *Appendix 3. Graphical Test Results.*

Test Summary:

Port:	Enclosure
Basic Standard:	EN 55022: 1998
Measurement Distance:	5 m
Frequency Range:	30 MHz to 1 GHz
Operating Mode:	Unit 2, CH3 Complete Setup (1)

Environmental Conditions:

Temperature Variation (°C):	28 to 28
Relative Humidity Variation (%):	60 to 60
Atmospheric Pressure Variation (mb):	1011 to 1011

Results:

Frequency (MHz)	Antenna Polarity	Quasi Peak Level (dB μ V/m)	Limit (dB μ V/m)	Margin (dB)	Note(s)	Result
319.967536	Horizontal	46.7	43.02	-3.68	1	Did Not Comply
479.968337	Vertical	46.7	43.02	-3.68	1	Did Not Comply
719.982765	Horizontal	48.3	43.02	-5.28	-	Did Not Comply
799.981162	Horizontal	47.7	43.02	-4.68	1	Did Not Comply
959.971543	Vertical	48.9	43.02	-5.88	-	Did Not Comply

Note(s):

1. The measured result lies outside the test standard limit by a margin less than the measurement uncertainty; it is therefore not possible to state compliance based on the 95% level of confidence. However, the result indicates that non-compliance is more probable than compliance.

5.3.4. Electric Field Strength Measurements

Plots of the initial scans can be found in *Appendix 3. Graphical Test Results.*

Test Summary:

Port:	Enclosure
Basic Standard:	EN 55022: 1998
Measurement Distance:	5 m
Frequency Range:	30 MHz to 1 GHz
Operating Mode:	Unit 2, CH4 No Laptop, Ethernet

Environmental Conditions:

Temperature Variation (°C):	28 to 28
Relative Humidity Variation (%):	60 to 60
Atmospheric Pressure Variation (mb):	1011 to 1011

Results:

Frequency (MHz)	Antenna Polarity	Quasi Peak Level (dBμV/m)	Limit (dBμV/m)	Margin (dB)	Note(s)	Result
30.952305	Vertical	40.4	36.02	-4.38	1	Did Not Comply
239.993988	Horizontal	53.9	43.02	-10.88	-	Did Not Comply
290.845291	Vertical	10.4	43.02	32.62	-	Complied
959.993186	Horizontal	45.4	43.02	-2.38	1	Did Not Comply

Note(s):

1. The measured result lies outside the test standard limit by a margin less than the measurement uncertainty; it is therefore not possible to state compliance based on the 95% level of confidence. However, the result indicates that non-compliance is more probable than compliance.

5.3.5. Electric Field Strength Measurements

Plots of the initial scans can be found in *Appendix 3. Graphical Test Results.*

Test Summary:

Port:	Enclosure
Basic Standard:	EN 55022: 1998
Measurement Distance:	5 m
Frequency Range:	30 MHz to 1 GHz
Operating Mode:	Unit 2, CH4 No Laptop No Ethernet

Environmental Conditions:

Temperature Variation (°C):	28 to 28
Relative Humidity Variation (%):	60 to 60
Atmospheric Pressure Variation (mb):	1011 to 1011

Results:

Frequency (MHz)	Antenna Polarity	Quasi Peak Level (dB μ V/m)	Limit (dB μ V/m)	Margin (dB)	Note(s)	Result
31.619639	Vertical	43.8	36.02	-7.78	-	Did Not Comply
800.010020	Horizontal	42.8	43.02	0.22	1	Complied
960.043687	Vertical	39.8	43.02	3.22	1	Complied

Note(s):

1. The measured result is within the test standard limit by a margin less than the measurement uncertainty; it is therefore not possible to state compliance based on the 95% level of confidence. However, the result indicates that compliance is more probable than non-compliance.

6. Measurement Uncertainty

No measurement or test can ever be perfect and the imperfections give rise to error of measurement in the results. Consequently, the result of a measurement is only an approximation to the value of the measurand (the specific quantity subject to measurement) and is only complete when accompanied by a statement of the uncertainty of the approximation.

The expression of uncertainty of a measurement result allows realistic comparison of results with reference values and limits given in specifications and standards.

The uncertainty of the result may need to be taken into account when interpreting the measurement results.

The reported expanded uncertainties below are based on a standard uncertainty multiplied by an appropriate coverage factor, such that a confidence level of approximately 95% is maintained. For the purposes of this document “approximately” is interpreted as meaning “effectively” or “for most practical purposes”.

Measurement Type	Range	Confidence Level	Calculated Uncertainty
Conducted disturbance at mains terminals and telecommunication ports	150 kHz to 30 MHz	95%	±3.72 dB
Radiated disturbance	30 MHz to 1000 MHz	95%	±4.68 dB

The methods used to calculate the above uncertainties are in line with those recommended within the various measurement specifications. Where measurement specifications do not include guidelines for the evaluation of measurement uncertainty, the published guidance of the appropriate accreditation body is followed.

Appendix 1. Test Equipment Used

RFI No.	Instrument	Manufacturer	Type No.	Serial No.
A067	Line Impedance Stabilization Network	Rohde & Schwarz	ESH3-Z5	890603/002
A1792	Pre Amplifier	A.H. Systems Inc	PAM-0118	182
A1829	Pulse Limiter	Rhode & Schwarz	ESH3-Z2	100671
A259	Antenna	Chase	CBL6111	1513
A276	OATS Positioning Controller	Rohde & Schwarz	HCC	
A492	RF Current Probe	Rohde & Schwarz	ESH2-Z1	845 048/020
C1302	3m Cable	Rosenberger	FA210A1030005050	59153-01
C1304	3m Cable	Rosenberger	FA210A1030005050	59153-02
M1273	Test Receiver	Rohde & Schwarz	ESIB 26	100275

NB In accordance with UKAS requirements, all the measurement equipment is on a calibration schedule.

Appendix 2. Test Configuration Drawings

This Appendix contains the following drawings:

Drawing Reference Number	Title
DRG\73935JD01\001	Schematic diagram of the EUT, support equipment and interconnecting cables used for the test

DRG\73935JD01\001

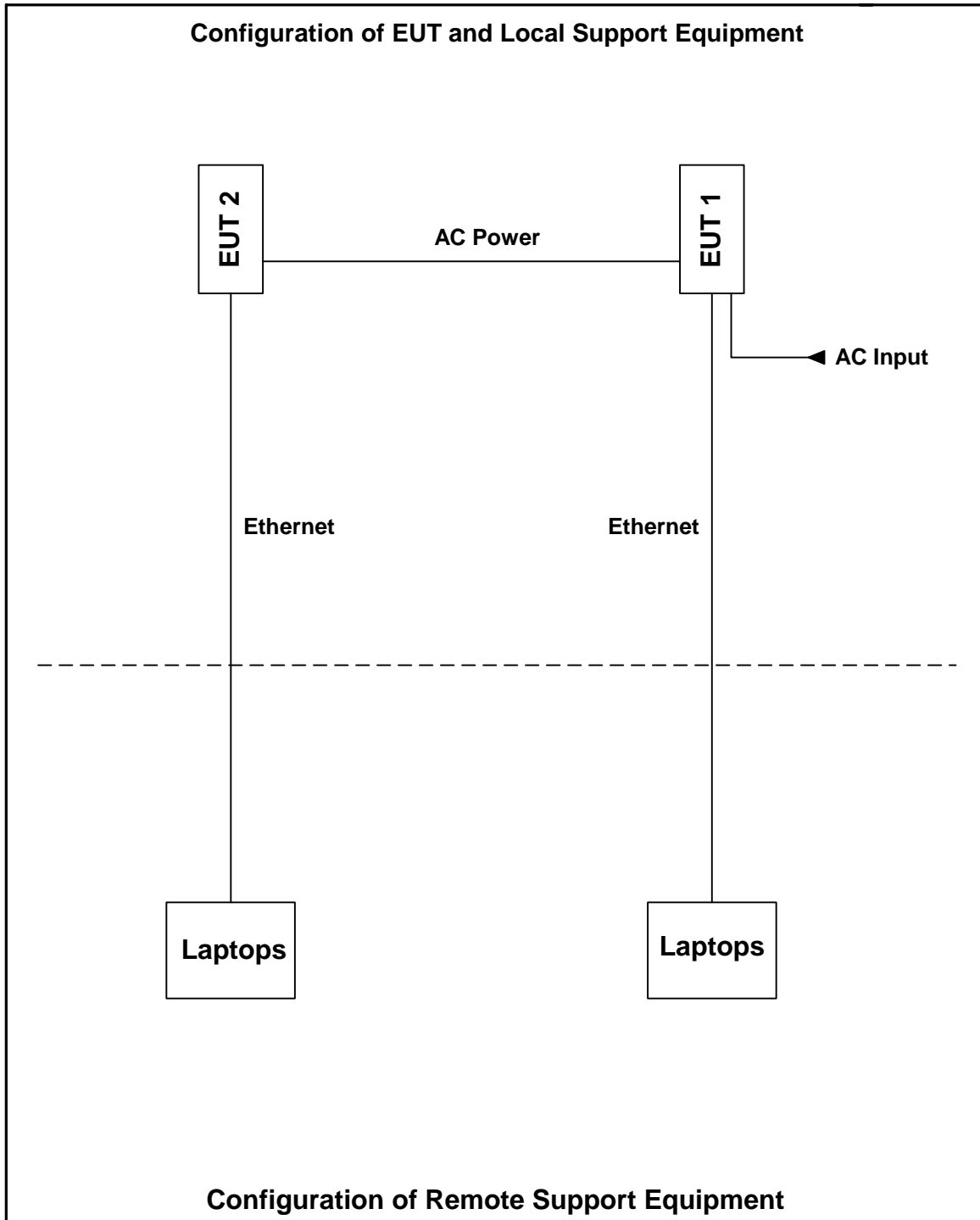

Appendix 3. Graphical Test Results

This Appendix contains the following graphs:

Graph Reference Number	Title
GPH\73935JD01\001	Conducted Disturbance Pre-Scan (0.15 MHz to 30 MHz) Current Clamp Unit CH3 Ethernet Data No Laptops
GPH\73935JD01\002	Conducted Disturbance Pre-Scan (0.15 MHz to 30 MHz) Current Clamp Unit CH4 Ethernet Data
GPH\73935JD01\003	Conducted Disturbance Pre-Scan (0.15 MHz to 30 MHz) Current Clamp Unit CH4 Ethernet No Data
GPH\73935JD01\004	Conducted Disturbance Pre-Scan (0.15 MHz to 30 MHz) Unit CH3 Ethernet Data
GPH\73935JD01\005	Conducted Disturbance Pre-Scan (0.15 MHz to 30 MHz) Unit CH3 Ethernet Data (1)
GPH\73935JD01\006	Conducted Disturbance Pre-Scan (0.15 MHz to 30 MHz) Unit CH3 Ethernet Unplugged Unit 1
GPH\73935JD01\007	Conducted Disturbance Pre-Scan (0.15 MHz to 30 MHz) Unit CH3 Ethernet Unplugged Unit 2
GPH\73935JD01\008	Conducted Disturbance Pre-Scan (0.15 MHz to 30 MHz) Unit CH3 Full Setup
GPH\73935JD01\009	Conducted Disturbance Pre-Scan (0.15 MHz to 30 MHz) Unit CH3 Full Setup No Data
GPH\73935JD01\010	Conducted Disturbance Pre-Scan (0.15 MHz to 30 MHz) Unit CH4 Ethernet Unplugged Unit 1
GPH\73935JD01\011	Conducted Disturbance Pre-Scan (0.15 MHz to 30 MHz) Unit CH4 Ethernet Unplugged Unit 2
GPH\73935JD01\012	Conducted Disturbance Pre-Scan (0.15 MHz to 30 MHz) Unit CH4 Full Setup
GPH\73935JD01\013	Conducted Disturbance Pre-Scan (0.15 MHz to 30 MHz) Unit CH4 Full Setup No Data
GPH\73935JD01\014	Conducted Disturbance Pre-Scan (0.15 MHz to 30 MHz) Unit CH5 Full Setup

Graph Reference Number	Title
GPH\73935JD01\015	Radiated Disturbance Pre-Scan (30 MHz to 1000 MHz) Unit 1, CH3, Laptop 1
GPH\73935JD01\016	Radiated Disturbance Pre-Scan (30 MHz to 1000 MHz) Unit 1, CH3, Laptop 1 (1)
GPH\73935JD01\017	Radiated Disturbance Pre-Scan (30 MHz to 1000 MHz) Unit 2, CH1 No Laptops
GPH\73935JD01\018	Radiated Disturbance Pre-Scan (30 MHz to 1000 MHz) Unit 2, CH3 Complete Setup
GPH\73935JD01\019	Radiated Disturbance Pre-Scan (30 MHz to 1000 MHz) Unit 2, CH3 Complete Setup (1)
GPH\73935JD01\020	Radiated Disturbance Pre-Scan (30 MHz to 1000 MHz) Unit 2, CH4 No Laptop Ethernet
GPH\73935JD01\021	Radiated Disturbance Pre-Scan (30 MHz to 1000 MHz) Unit 2, CH4 No Laptop No Ethernet

GPH\73935JD01\001
Conducted Disturbance Pre-Scan (0.15 MHz to 30 MHz)

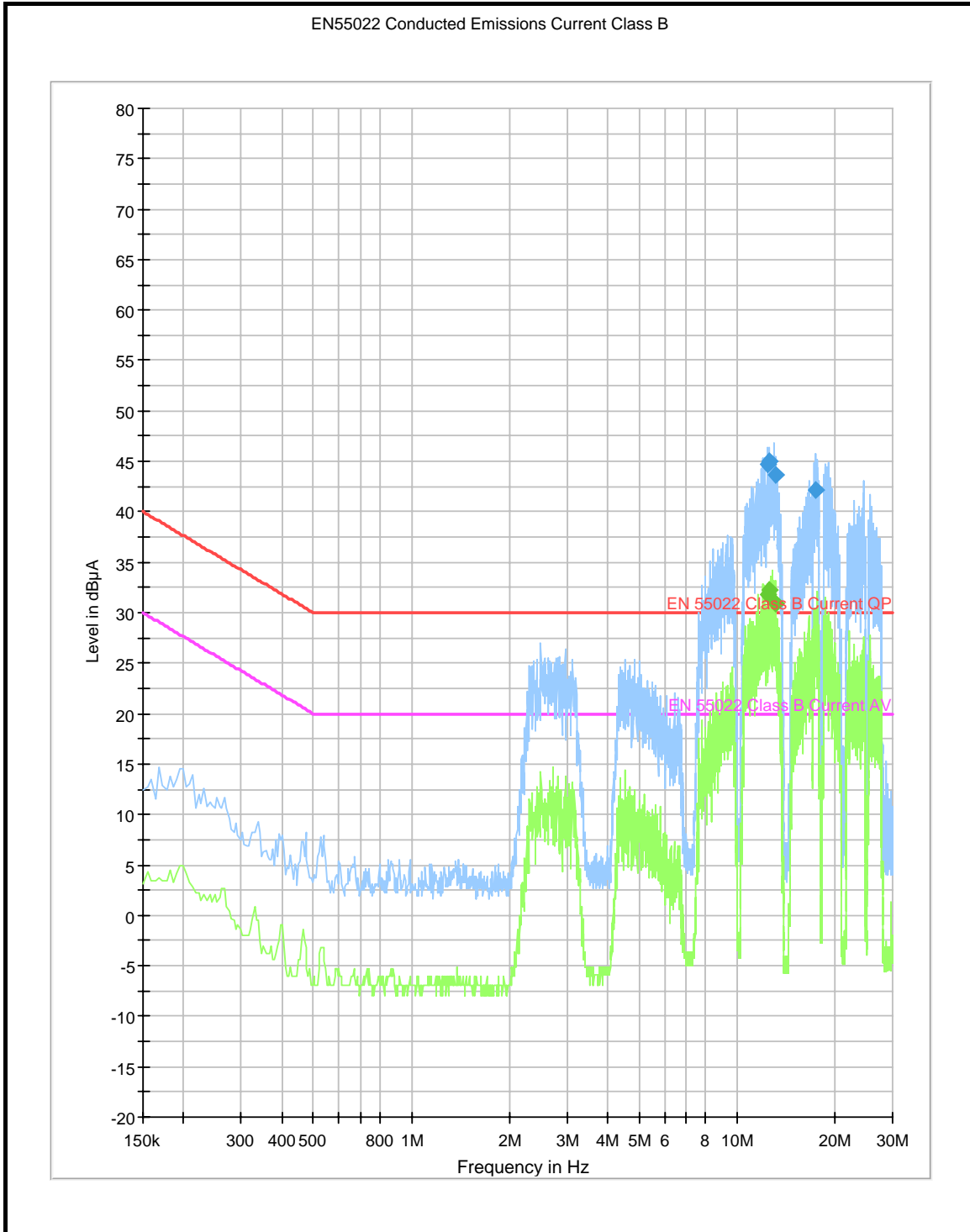

GPH73935JD01\002
Conducted Disturbance Pre-Scan (0.15 MHz to 30 MHz)

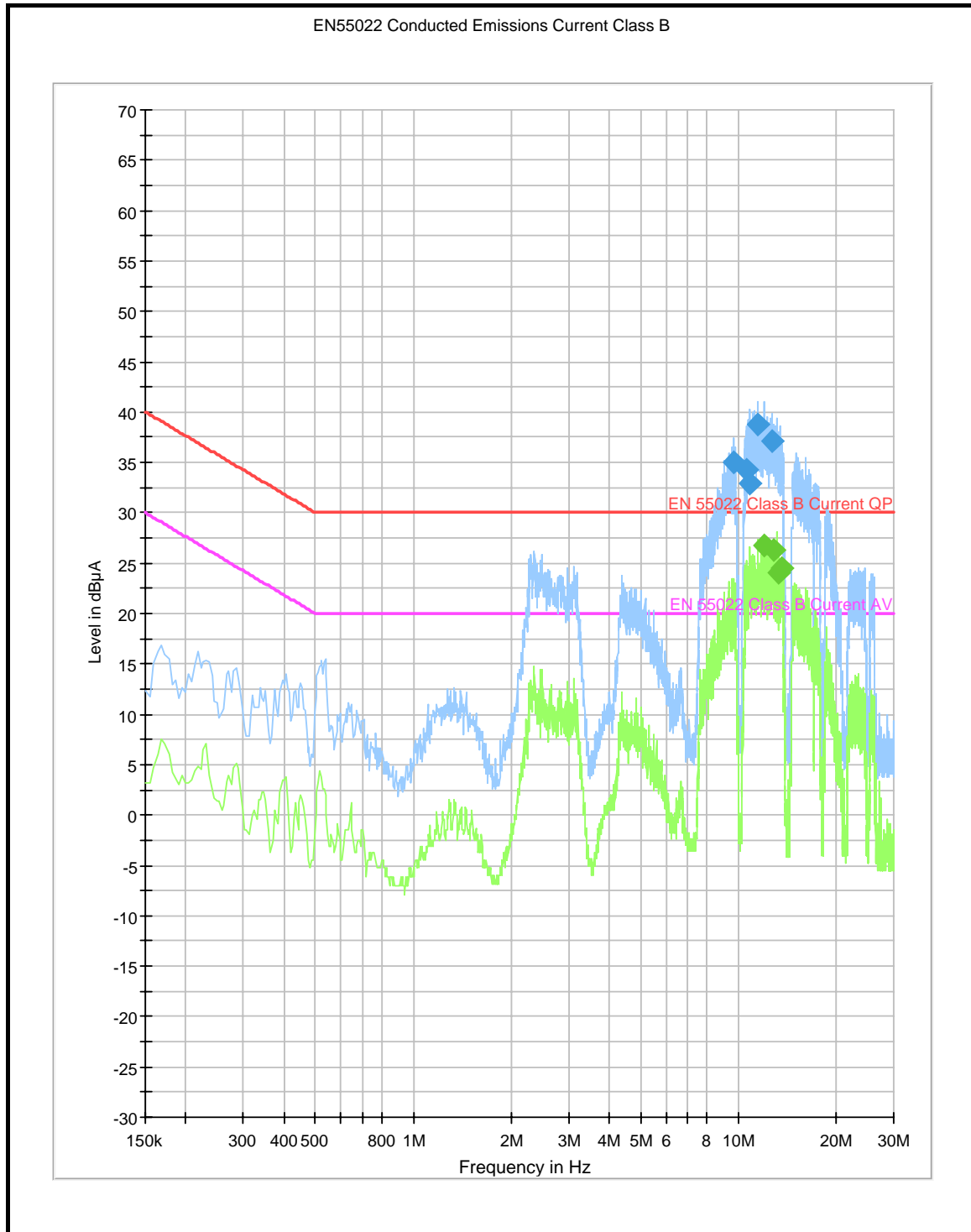

GPH73935JD01\003
Conducted Disturbance Pre-Scan (0.15 MHz to 30 MHz)

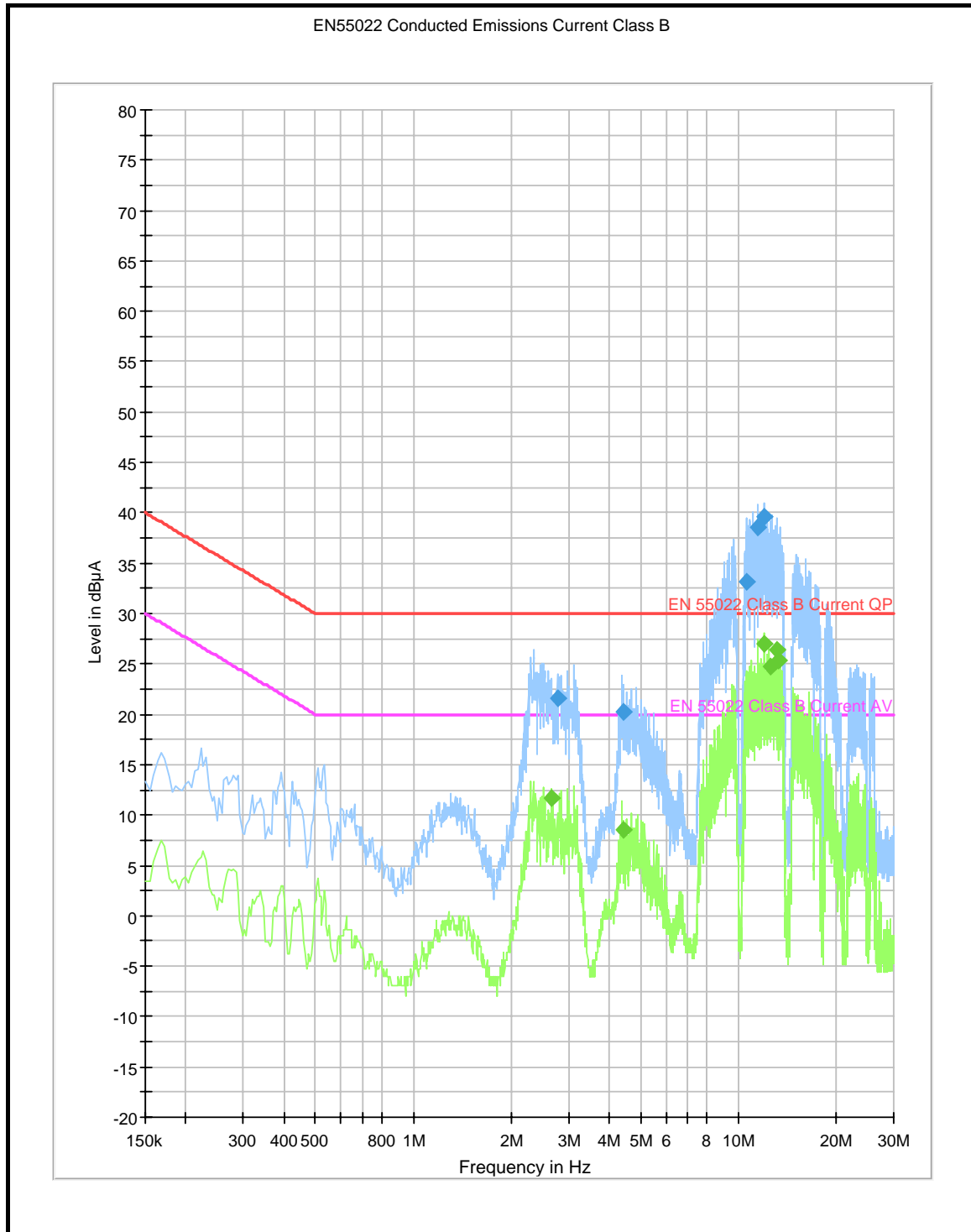

GPH73935JD01\004
Conducted Disturbance Pre-Scan (0.15 MHz to 30 MHz)

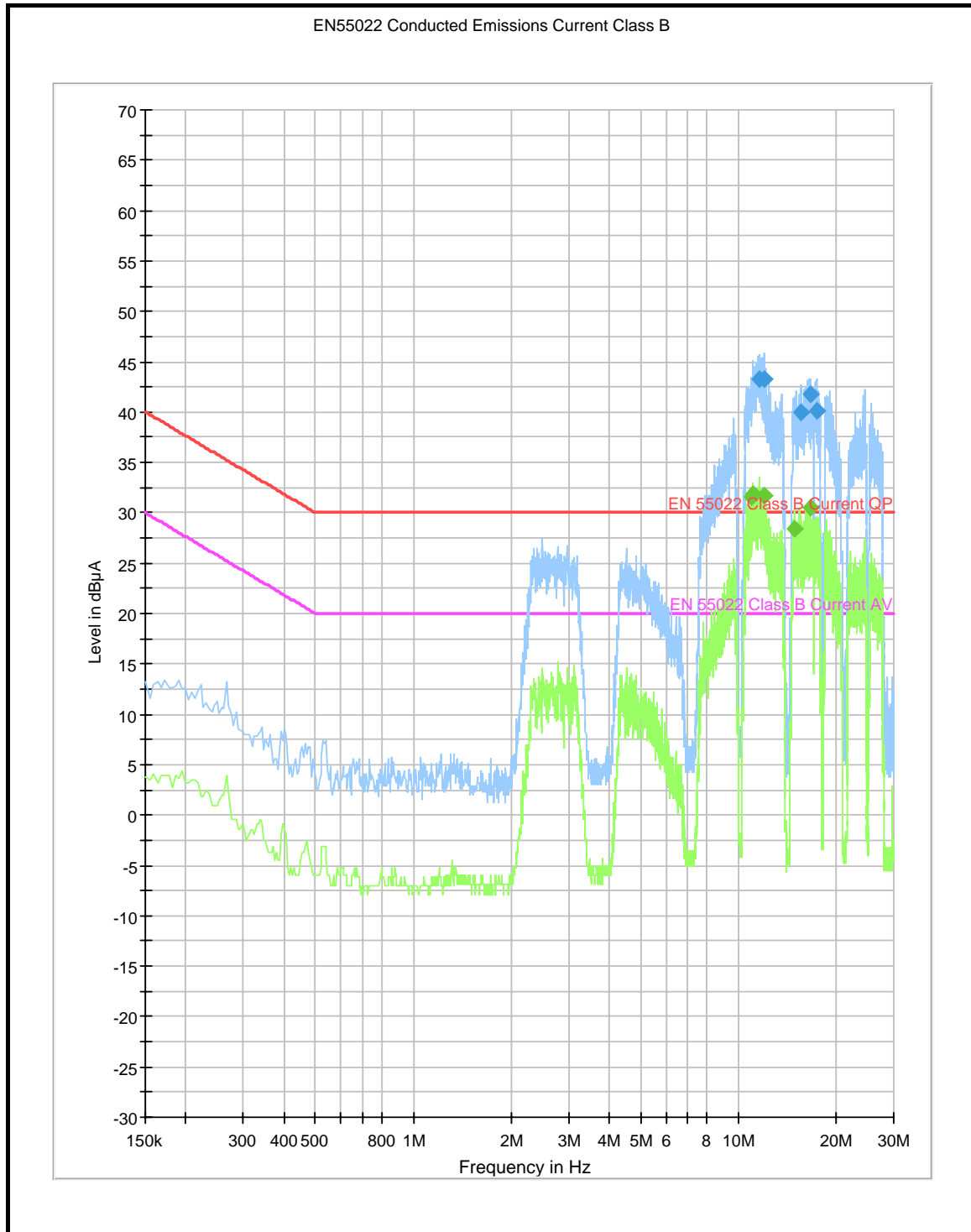

GPH73935JD01\005
Conducted Disturbance Pre-Scan (0.15 MHz to 30 MHz)

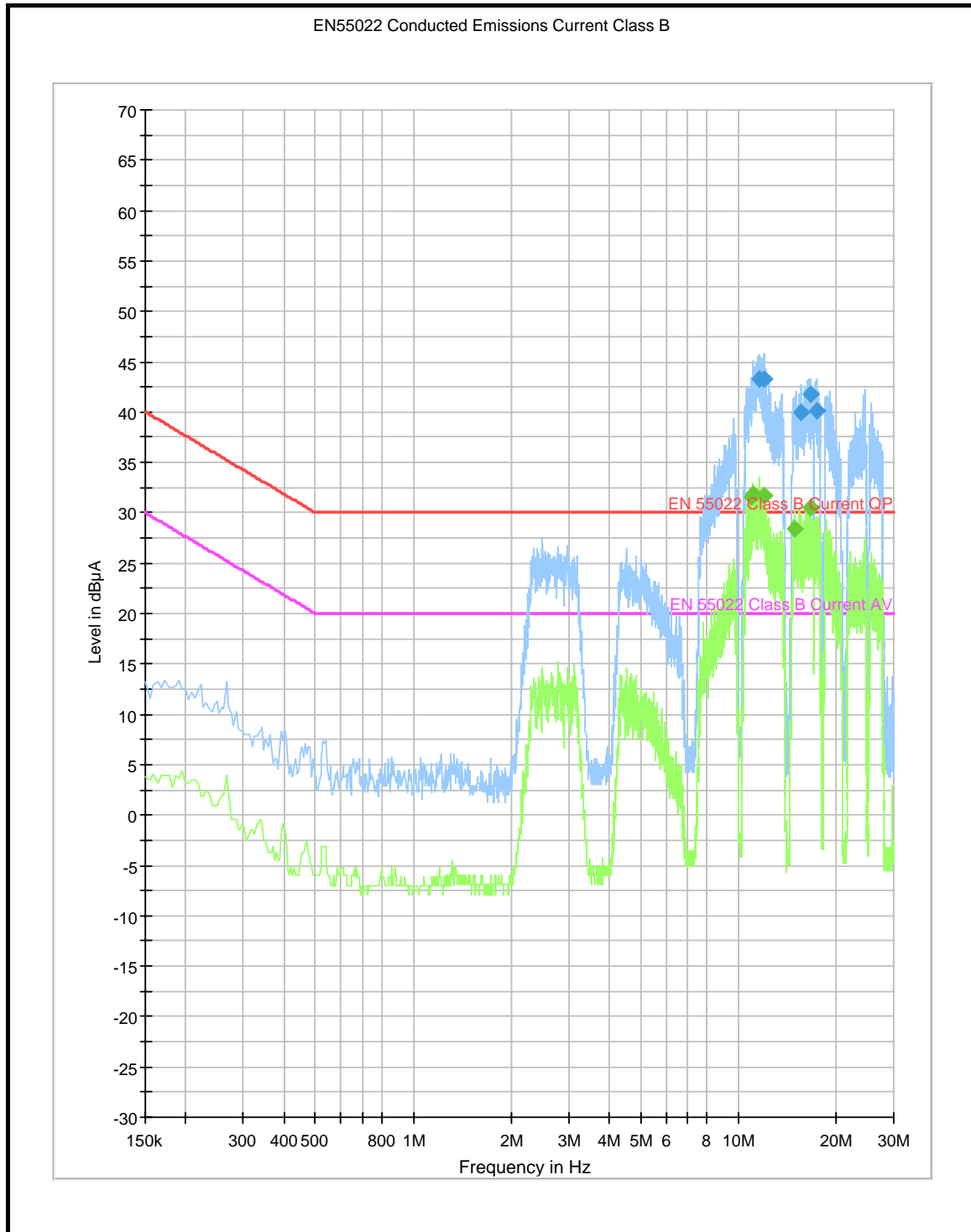

GPH73935JD01\006
Conducted Disturbance Pre-Scan (0.15 MHz to 30 MHz)

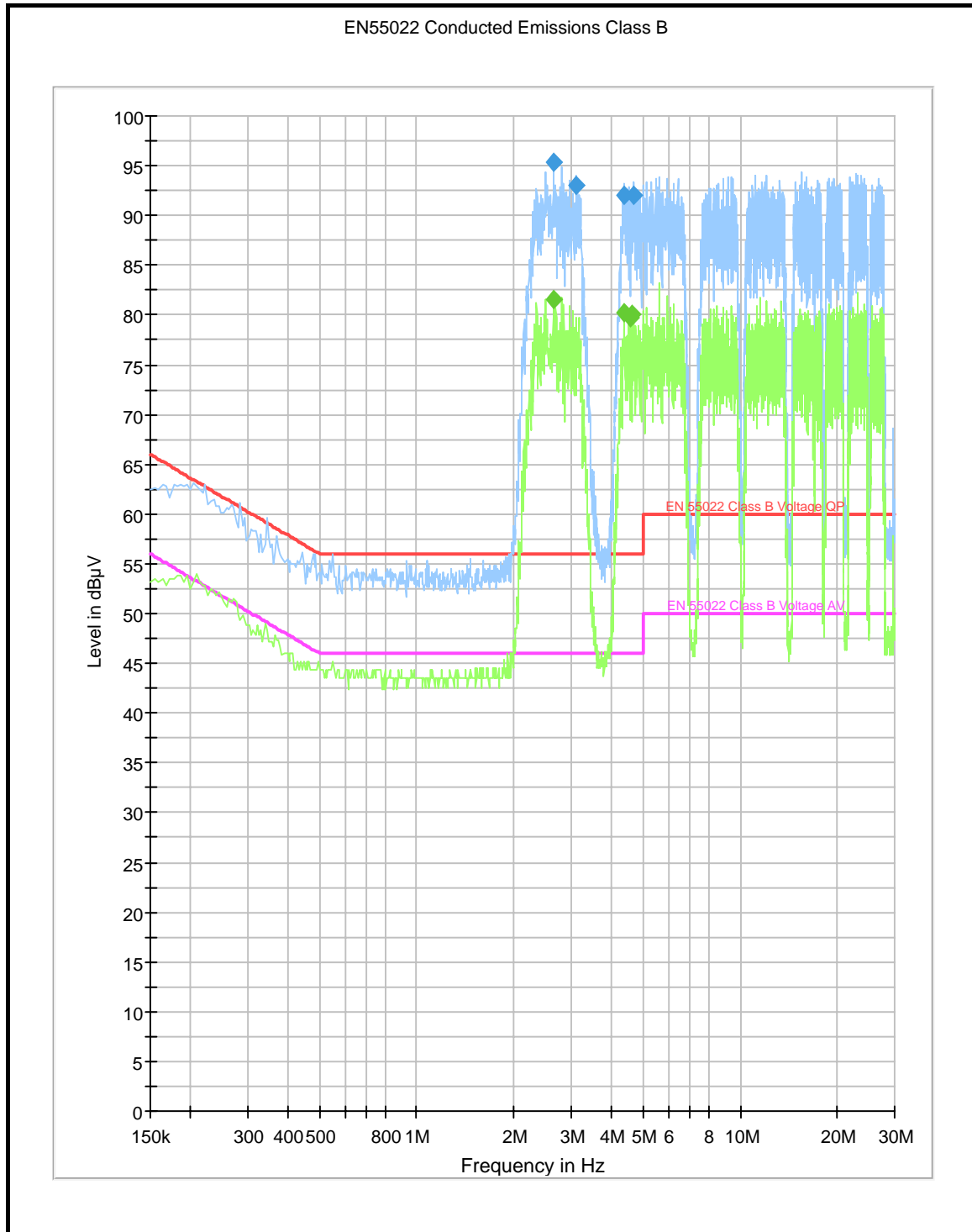

GPH73935JD01\007
Conducted Disturbance Pre-Scan (0.15 MHz to 30 MHz)

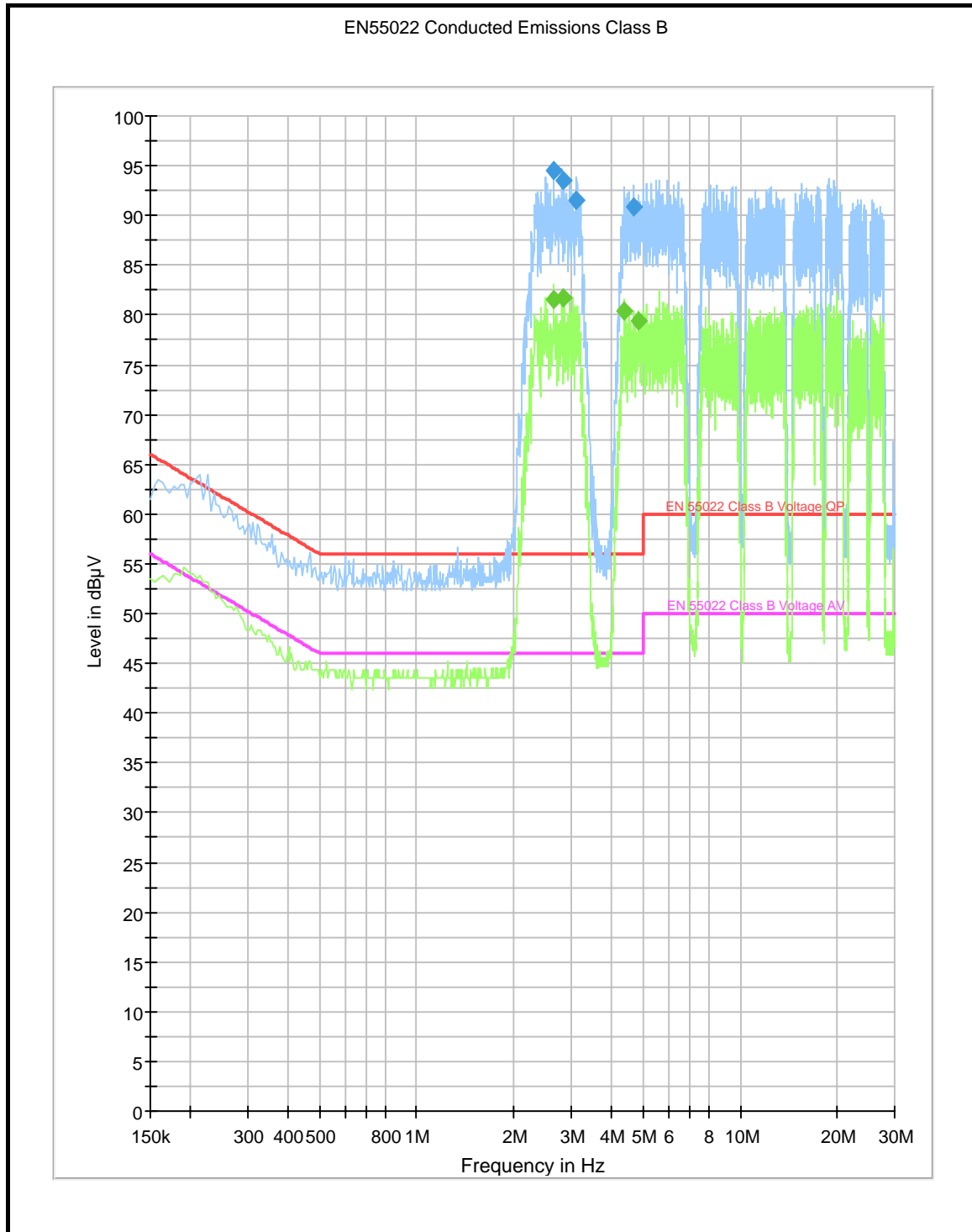

GPH73935JD01\008
Conducted Disturbance Pre-Scan (0.15 MHz to 30 MHz)

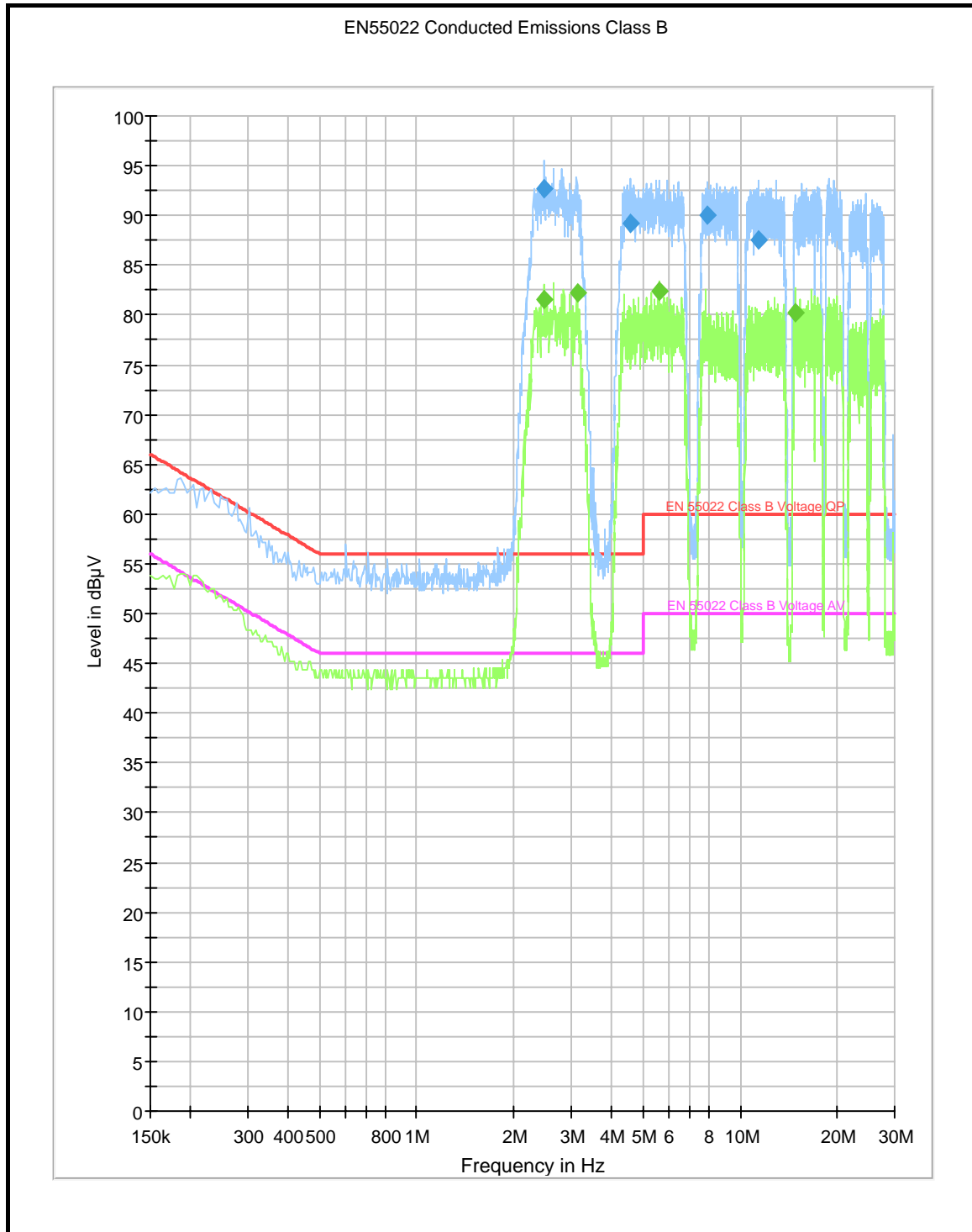

GPH\73935JD01\009
Conducted Disturbance Pre-Scan (0.15 MHz to 30 MHz)

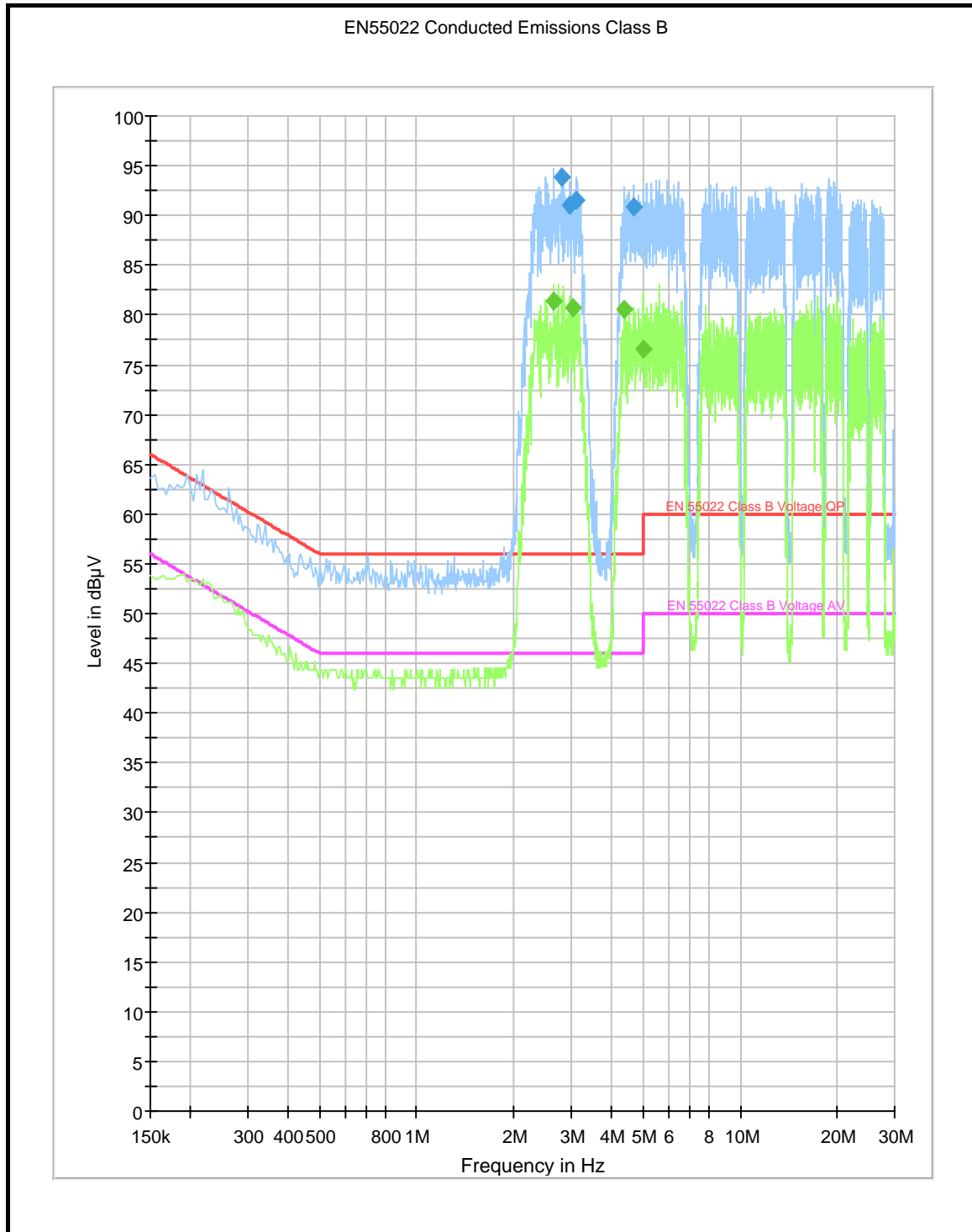

GPH73935JD01\010
Conducted Disturbance Pre-Scan (0.15 MHz to 30 MHz)

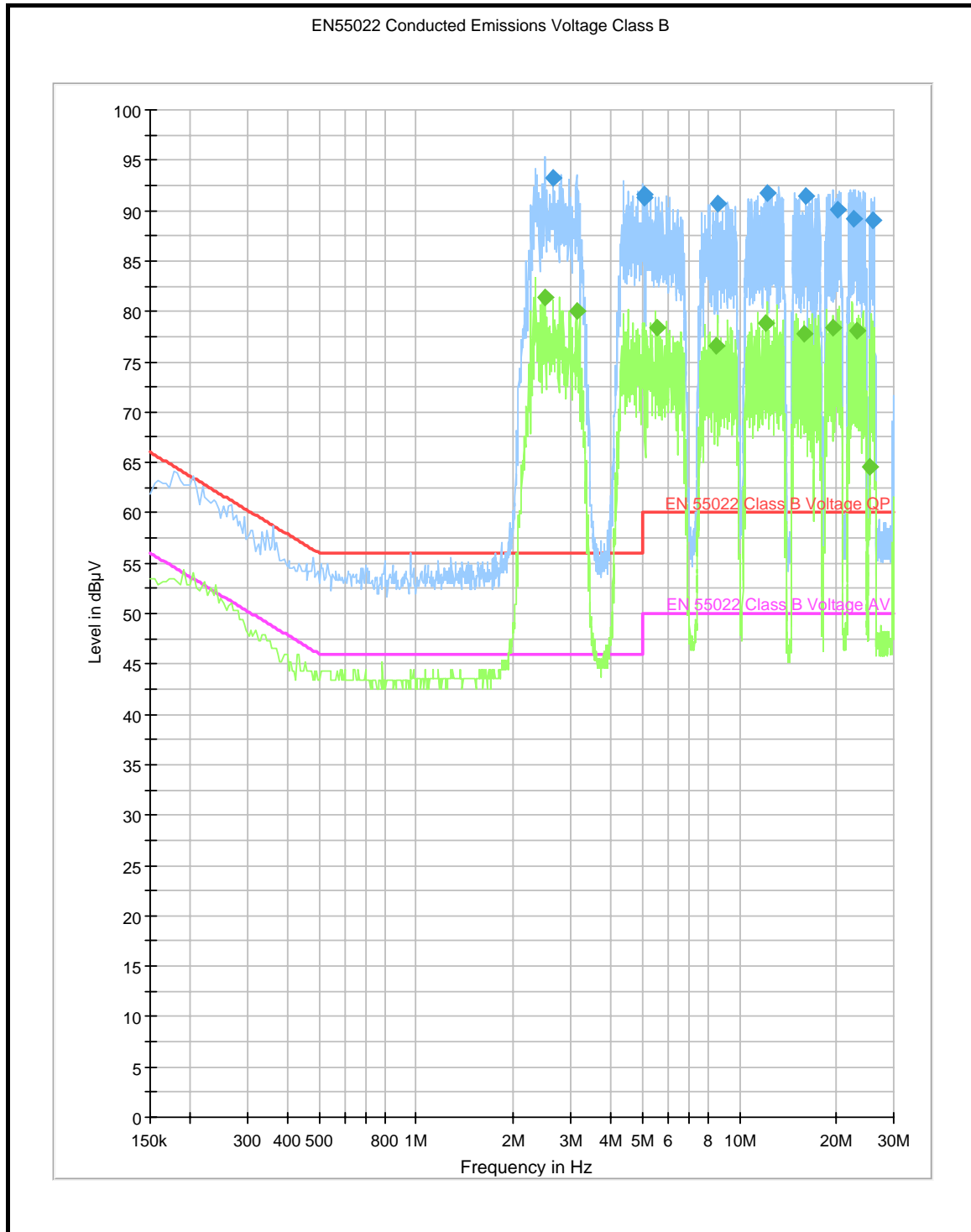

GPH73935JD01\011
Conducted Disturbance Pre-Scan (0.15 MHz to 30 MHz)



GPH73935JD01\012
Conducted Disturbance Pre-Scan (0.15 MHz to 30 MHz)

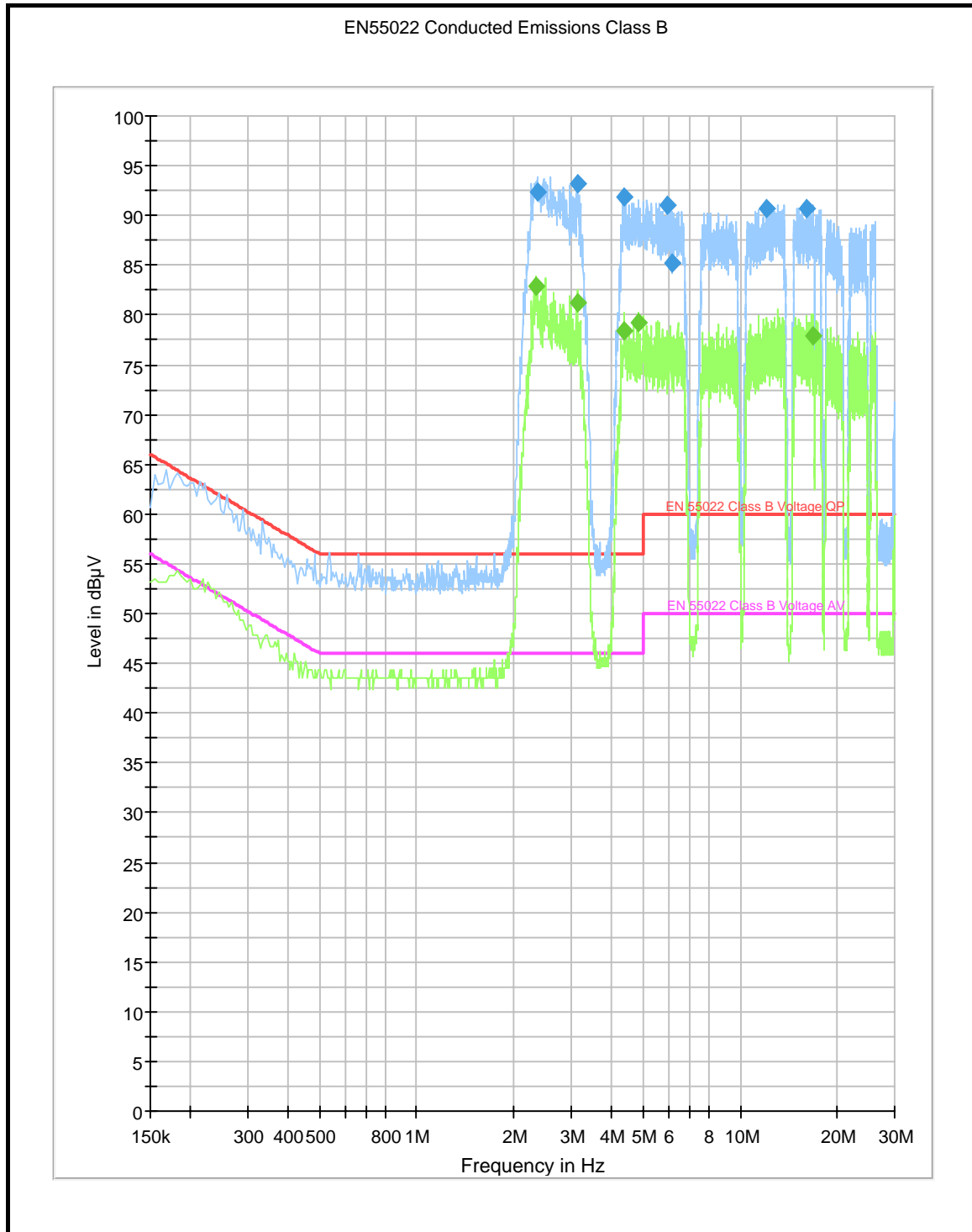

GPH73935JD01\013
Conducted Disturbance Pre-Scan (0.15 MHz to 30 MHz)

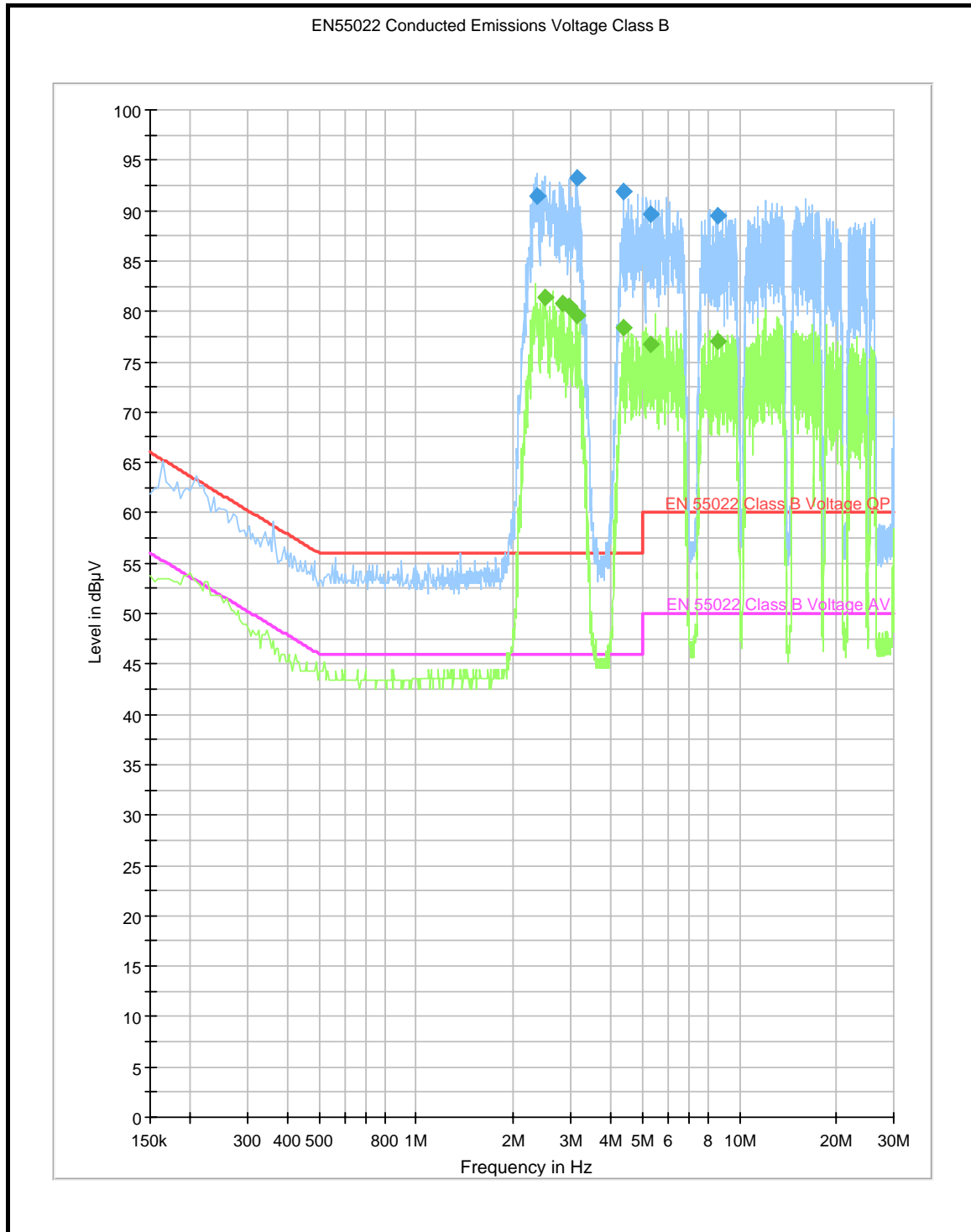

GPH73935JD01\014
Conducted Disturbance Pre-Scan (0.15 MHz to 30 MHz)

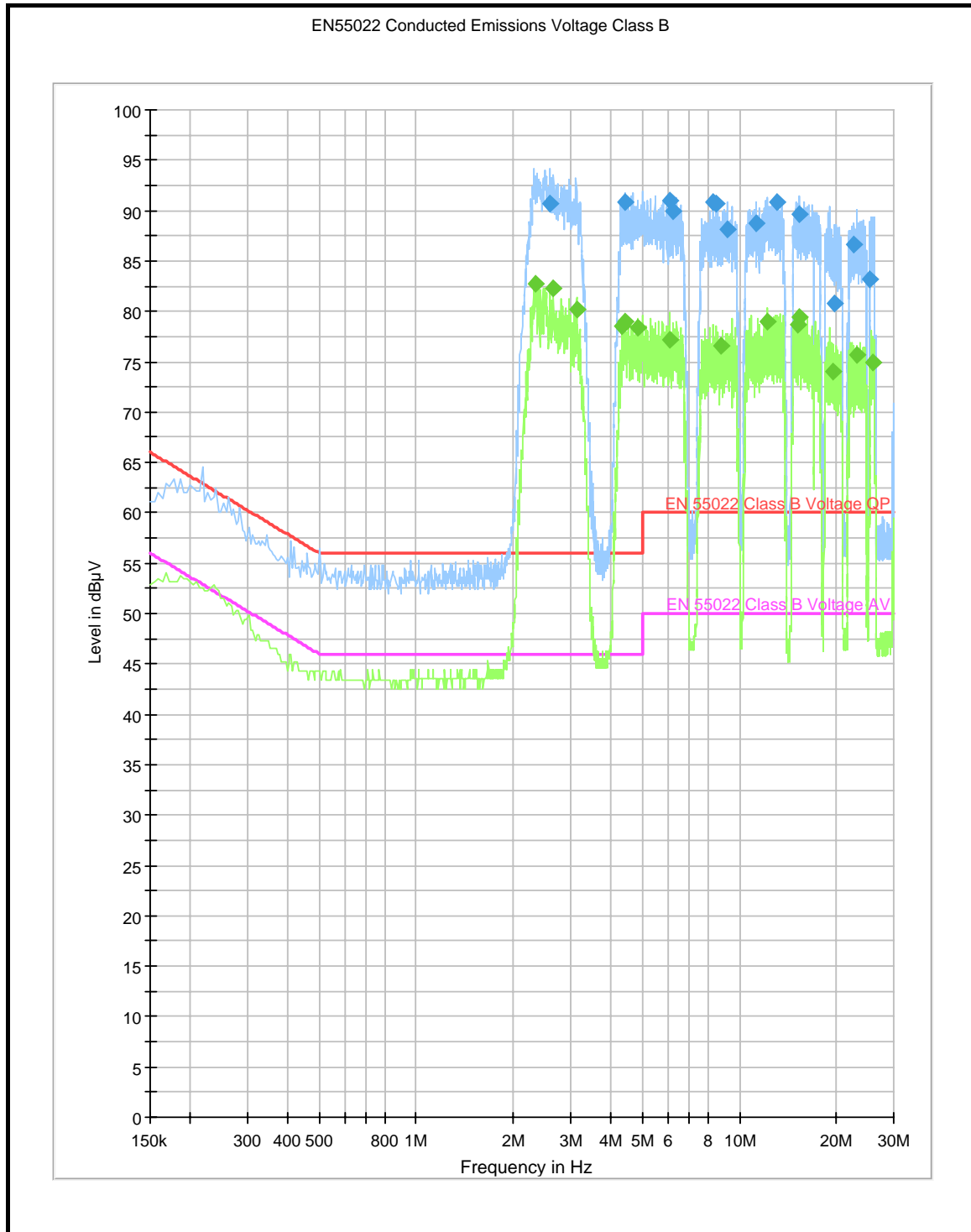

GPH73935JD01\015
Radiated Disturbance Pre-Scan (30 MHz to 1000 MHz)

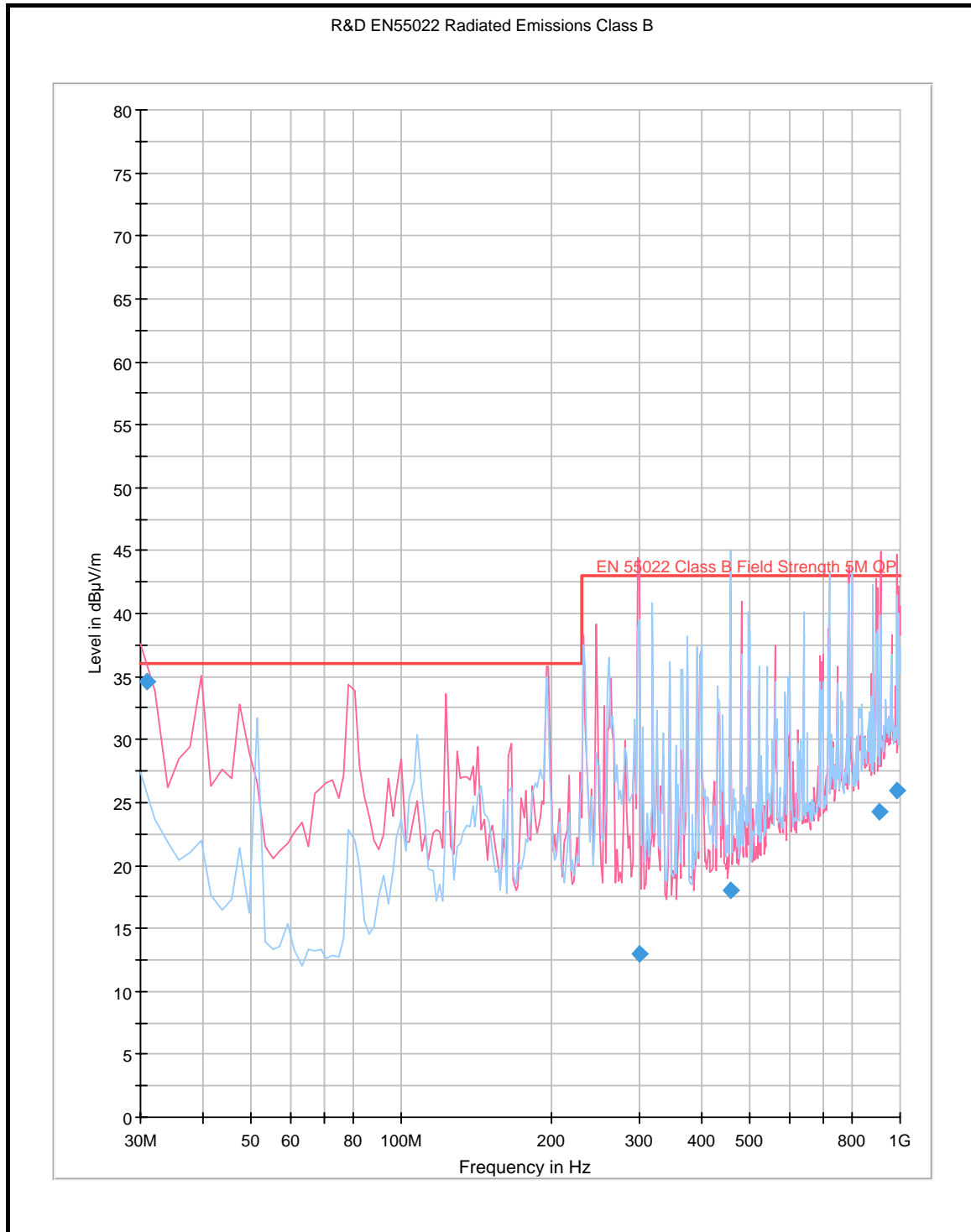

GPH73935JD01\016
Radiated Disturbance Pre-Scan (30 MHz to 1000 MHz)

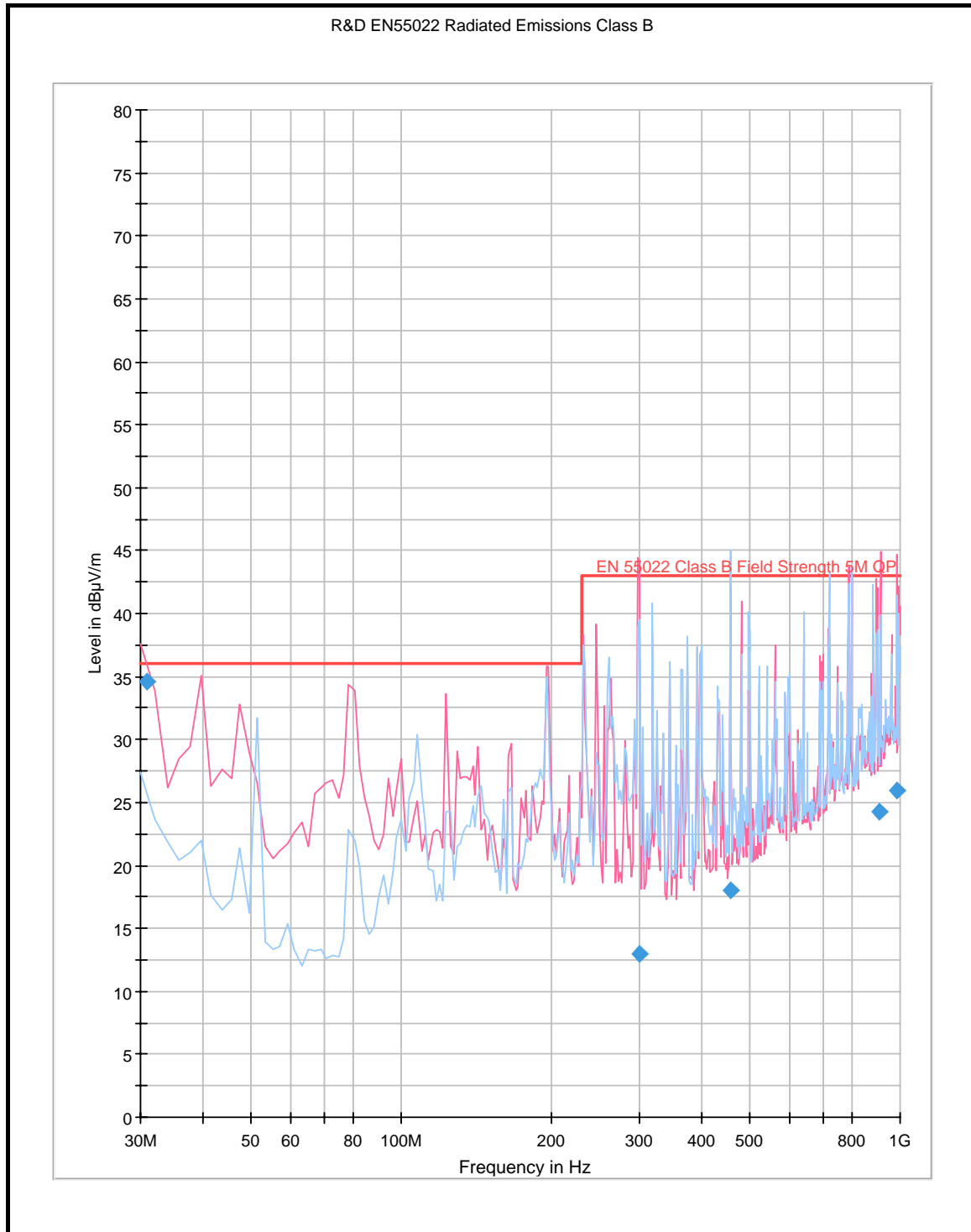

GPH73935JD01\017
Radiated Disturbance Pre-Scan (30 MHz to 1000 MHz)

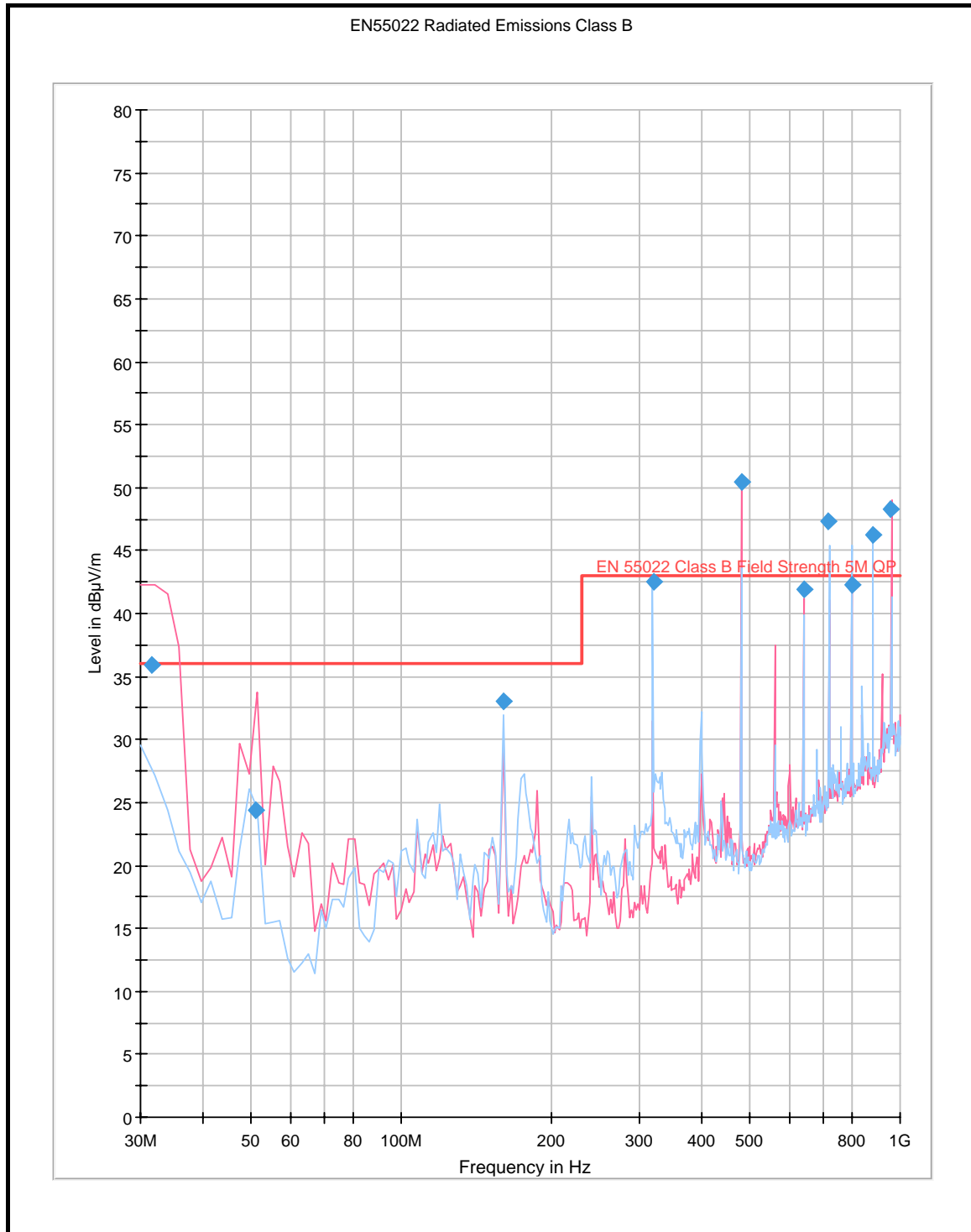

GPH\73935JD01\018
Radiated Disturbance Pre-Scan (30 MHz to 1000 MHz)

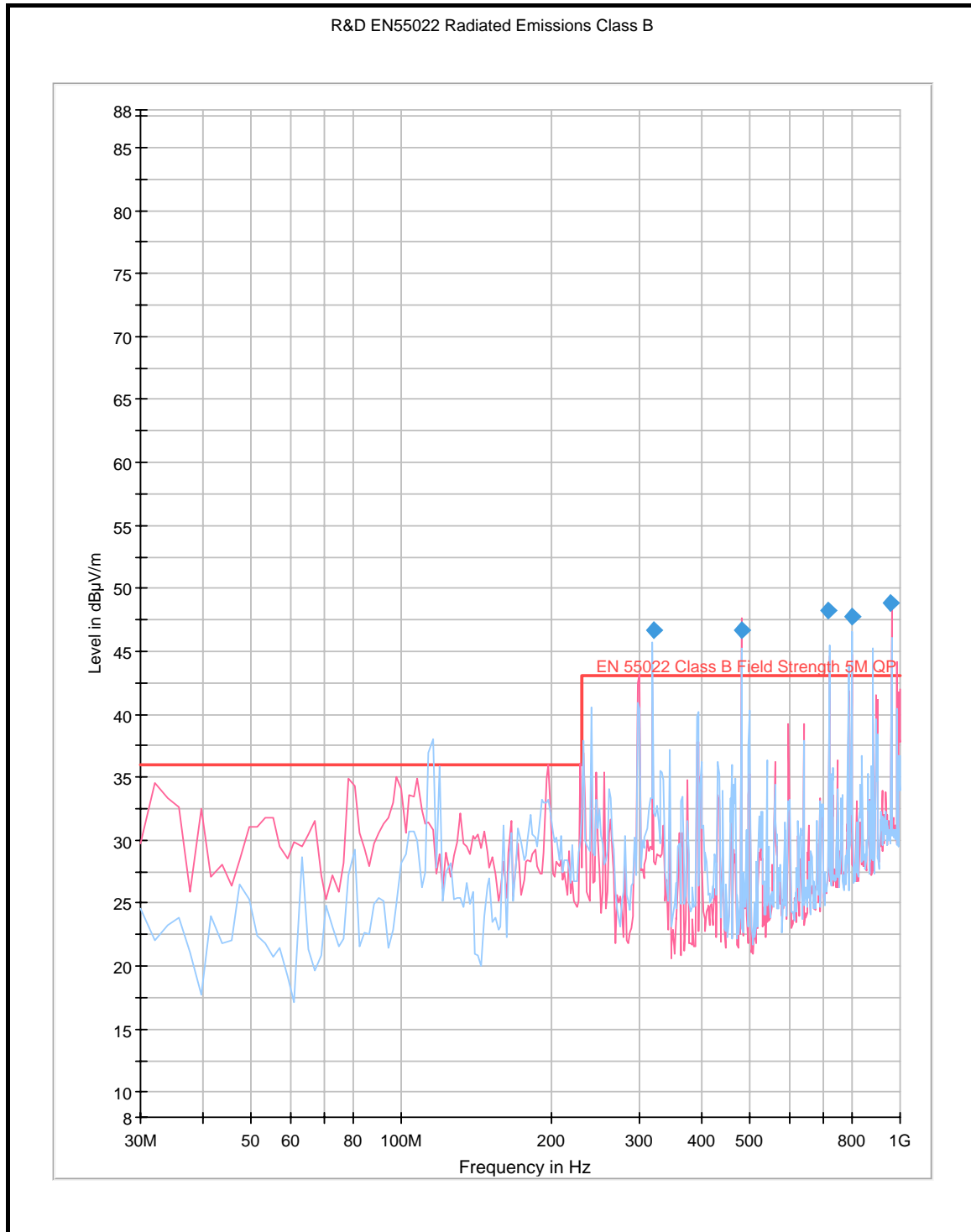

GPH73935JD01\019
Radiated Disturbance Pre-Scan (30 MHz to 1000 MHz)

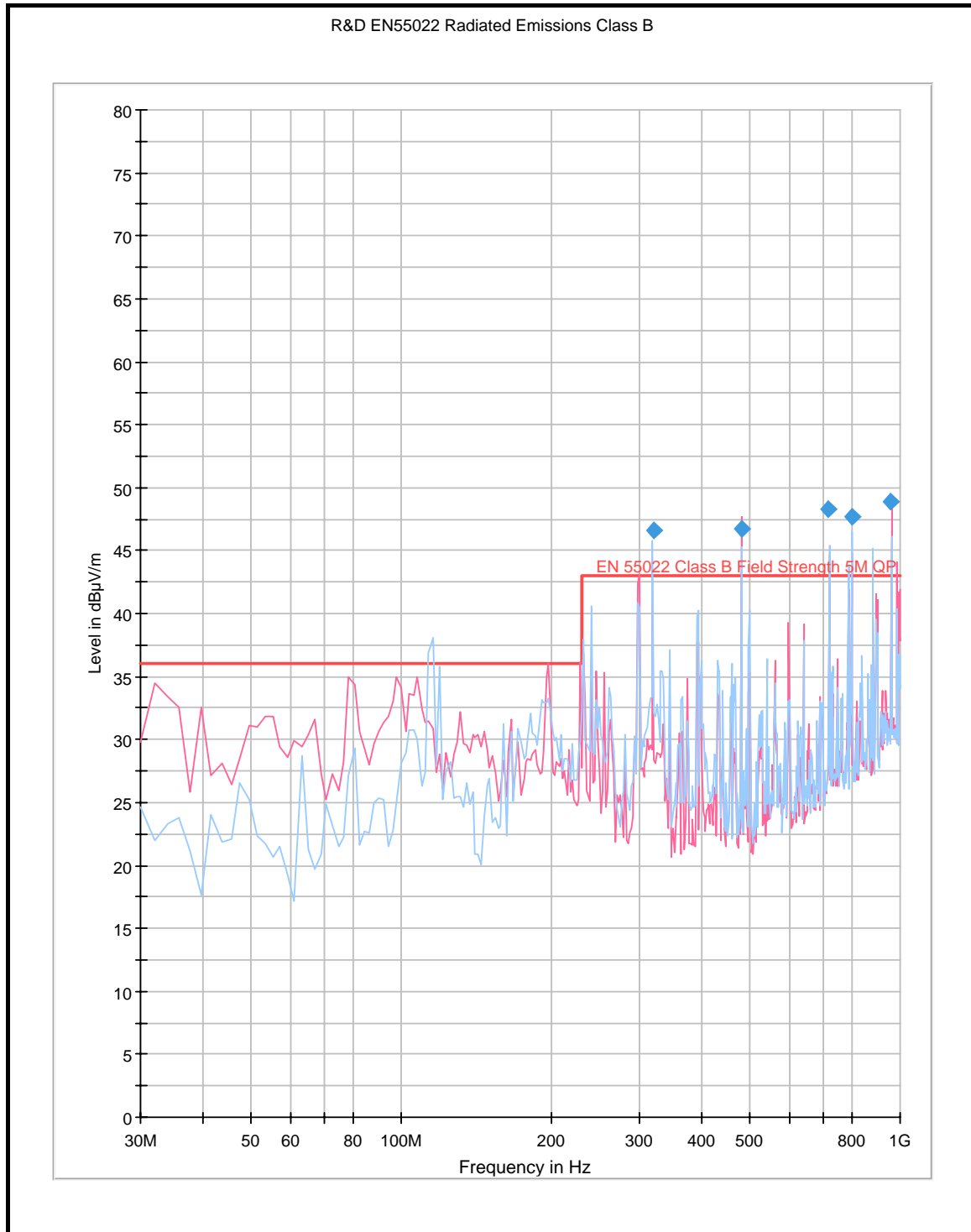

GPH73935JD01\020
Radiated Disturbance Pre-Scan (30 MHz to 1000 MHz)

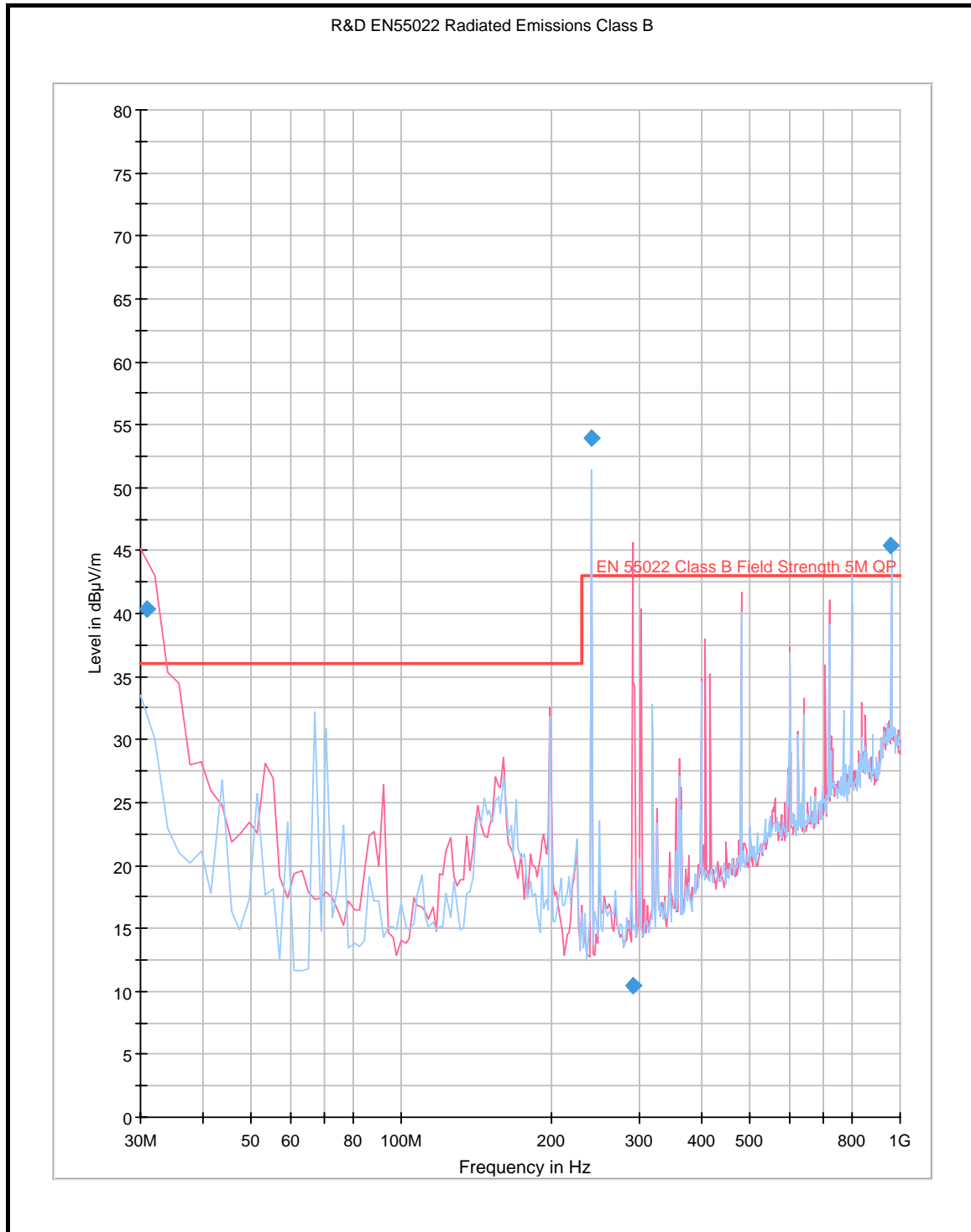

GPH73935JD01\021
Radiated Disturbance Pre-Scan (30 MHz to 1000 MHz)

